



United States  
Environmental Protection  
Agency

# Remediation of Radium from Contaminated Soil



# Remediation of Radium from Contaminated Soil

M. Misra  
R. K. Mehta  
P. Lan  
University of Nevada, Reno  
Reno, Nevada 89557

Cooperative Agreement No. CR-826147

Project Officer  
Mary Gonsoulin  
National Risk Management Research Laboratory  
Office of Research and Development  
U.S. Environmental Protection Agency  
Ada, Oklahoma 74820

National Risk Management Research Laboratory  
Office of Research and Development  
U.S. Environmental Protection Agency  
Cincinnati, Ohio 45268

---

## Notice

The U.S. Environmental Protection Agency through its Office of Research and Development partially funded and collaborated in the research described here under Cooperative Agreement No. CR-826147 to the University of Nevada, Reno. It has been subjected to the Agency's peer and administrative review and has been approved for publication as an EPA document. Mention of trade names or commercial products does not constitute endorsement or recommendation for use.

All research projects making conclusions or recommendations based on environmental data and funded by the U.S. Environmental Protection Agency are required to participate in the Agency Quality Assurance Program. This project was conducted under an approved Quality Assurance Project Plan. The procedures specified in this plan were used without exception. Information on the plan and documentation of the quality assurance activities and results are available from the Principal Investigator.

---

## Foreword

The U.S. Environmental Protection Agency is charged by Congress with protecting the Nation's land, air, and water resources. Under a mandate of national environmental laws, the Agency strives to formulate and implement actions leading to a compatible balance between human activities and the ability of natural systems to support and nurture life. To meet this mandate, EPA's research program is providing data and technical support for solving environmental problems today and building a science knowledge base necessary to manage our ecological resources wisely, understand how pollutants affect our health, and prevent or reduce environmental risks in the future.

The National Risk Management Research Laboratory (NRMRL) is the Agency's center for investigation of technological and management approaches for preventing and reducing risks from pollution that threatens human health and the environment. The focus of the Laboratory's research program is on methods and their cost-effectiveness for prevention and control of pollution to air, land, water, and subsurface resources; protection of water quality in public water systems; remediation of contaminated sites, sediments and ground water; prevention and control of indoor air pollution; and restoration of ecosystems. NRMRL collaborates with both public and private sector partners to foster technologies that reduce the cost of compliance and to anticipate emerging problems. NRMRL's research provides solutions to environmental problems by: developing and promoting technologies that protect and improve the environment; advancing scientific and engineering information to support regulatory and policy decisions; and providing the technical support and information transfer to ensure implementation of environmental regulations and strategies at the national, state, and community levels.

This report presents a discussion of the application of a physico-chemical separation process for the removal of radium from a sample of contaminated soil from the Ottawa site near Chicago. The size/activity distribution analyzed among the particles coarser than 5 micron showed that the activity was uniformly distributed. Almost 50% of the Ra-226 activity was associated with particles of size 5 micron and less. These size fractions are: coarse (+300 micron), medium (300 x 10 micron), and fine (-10 micron). On the basis of the test work conducted in this project, a flowsheet was developed which can be used for on-site demonstration, Figure 38. The report concludes with an outlook of possible future efforts needed in this research area. It is published and made available by EPA's Office of Research and Development to assist the user community.

Stephen G. Schmelling, Acting Director  
Subsurface Protection and Remediation Division  
National Risk Management Research Laboratory



---

## Abstract

The objective of this study was to demonstrate the application of a physico-chemical separation process for the removal of radium from a sample of contaminated soil at the Ottawa, Illinois, site near Chicago. The size/activity distribution analyzed among the particles coarser than 5 micron showed that the activity was uniformly distributed. Almost 50% of the Ra-226 activity was associated with particles of size 5 micron and less. These size fractions are: coarse (+300 micron), medium (300 x 10 micron), and fine (-10 micron).

A series of mild chloride washing and flotation experiments showed that the +300 micron and 300 x 10 micron size fraction can be remediated below a criterion level of 6 pCi/gm. This criterion was based upon the 5 pCi/g plus background standard of 40 CFR 192. The criterion is often a relevant and appropriate requirement for Superfund. Also, chemical washing utilizing the chloride based lixiviants was found to be potentially useful for the remediation of -10 micron soil fraction. The radium from coarse fraction up to 50 mesh (300 micron) could be easily removed by screening and chloride washing. However, there was a difficulty in achieving a low radium value in the medium sized fractions using flotation. In order to accomplish this goal, several different reagents (specific to radium), effect of temperature and the effect of chloride washing were evaluated.

Experimental results demonstrated that a combination of reagent using (R-801+8-HQ) was uniquely specific for radium. Using the combined flotation reagent, a volume reduction of 80% with a radium level of 6 pCi/gm was obtained. The tests showed that with chloride washing of coarse materials (+300 micron) and flotation of 300 micron x 10 micron, the overall volume reduction of 80% can be accomplished. The typical results are summarized below:

<b>RADIUM DECONTAMINATION RESULTS SUMMARY FOR OTTAWA SOIL</b>			
<b>Contaminated Soil Fraction</b>	<b>Weight %</b>	<b>Average Ra-226 Activity (pCi/g)</b>	<b>% of Original Soil as "Clean Soil" After Application of UNR Technologies</b>
+300 micron	43	26.2	40-41
-300 +10 micron	33	92.3	26-30
-10 micron	24	180	19-22
<b>Total Volume Reduction = 85-93%</b>			

The gross count analysis conducted at the University of Nevada, Reno was found to be consistent with the Ra-226 gamma scan data analyzed by Thermo NUtech on the selected samples.

On the basis of the test work conducted in this project, a flowsheet was developed which can be used for on-site demonstration. This report was submitted in fulfillment of Cooperative Agreement No. CR-826147 by the University of Nevada, Reno under the sponsorship of the United States Environmental Protection Agency. This report covers a period from 10/01/97 to 09/30/2000.



---

## Contents

1. Introduction .....	1
1.1 Background and Objective .....	1
1.2 Rationale .....	2
1.3 Scope .....	3
2. UNR Soil Washing Laboratory .....	5
2.1 Design .....	5
2.2 Operations .....	7
2.3 Acquisition of Soil and Laboratory Readiness .....	9
2.4 Performance Criterion .....	9
3. Soil Sample Characterization .....	11
3.1 Characterization of the Ra-Contaminated Ottawa Site Soil Sample .....	11
4. Description of Mechanical Flotation Technology .....	17
5. Surrogate Testing .....	19
5.1 Surrogate Development .....	19
5.2 Surrogate Characterization .....	19
5.2.1 Surface Charge Measurements .....	19
5.3 Hallimond Tube Flotation Experiments .....	19
5.3.1 Effect of Collector Concentration .....	19
5.3.2 Effect of pH .....	19
5.3.3 Mixture of Soil and Barite .....	22
6. Soil Testing .....	23
6.1 Flotation Tests Procedure .....	23
6.2 Salt Solution Washing/Filtration Tests .....	34
6.3 Salt Solution Washing/Sieving Tests .....	39
6.4 Coating Tests .....	42
7. Conclusions .....	45
8. Recommendations .....	47
References .....	49





---

## Figures

1	Schematic of soil washing laboratory .....	5
2	Soil washing laboratory-personnel movement .....	7
3	Soil washing laboratory-soil movement .....	8
4	Soil washing laboratory-evacuation routes .....	8
5	Weight percent distribution in different size fractions .....	11
6	Schematic of vessel decantation .....	12
7	Ra-226 activity in different size fractions .....	14
8	Ra-226 activity distribution in different size fractions .....	14
9	Gross activity in different size fractions .....	15
10	Gross-activity distribution in different size fractions .....	15
11	Technological approach for separation of heavy metals from soils .....	18
12	Effect of pH on zeta potentials of barite and soil .....	20
13	Schematic of the Hallimond tube flotation cell .....	20
14	Effect of concentration of collector on barite flotation .....	21
15	Effect of pH on barite flotation with sodium lauryl sulfate .....	21
16	Effect of pH on barite flotation with sodium oleate .....	22
17	Selectivity test of barite and soil mixture .....	22
18	Schematic of automated mechanical cell .....	23
19	Flowsheet of experiment for flotation tests at natural pH .....	24
20	Flowsheet of experiment for magnetic separation of flotation tail .....	25
21	Flowsheet of experiment for flotation tests at high pH .....	26
22	Flowsheet of experiment for attritioning before flotation .....	27
23	Flowsheet of experiment for ultrasonic pretreatment before flotation .....	28
24	Flowsheet of experiment for desliming before flotation .....	29
25	Flowsheet of experiment for desliming before hot water flotation .....	30
26	Flowsheet of experiment for flotation at higher collector dosage .....	31
27	Flowsheet of experiment for flotation at higher collector dosage of 8-HQ .....	31
28	Flowsheet of experiment for flotation at higher collector dosage of cupferron .....	32
29	Flowsheet of experiment for flotation using combined R-801 and 8-HQ collectors .....	33
30	Washing test equipment .....	34
31	Flowsheet of experiment for washing/filtration with NaCl-HCl .....	35
32	Flowsheet of experiment for washing/filtration with NaCl-HCl .....	36
33	Flowsheet of experiment for washing/filtration with NaCl-HCl .....	37
34	Flowsheet of experiment for washing/filtration with NaCl-HCl .....	38
35	Flowsheet of experiment for washing/sieving with NaCl-HCl .....	39
36	Flowsheet of experiment for washing/sieving with NaCl-HCl .....	40
37	Flowsheet of experiment for extended washing/sieving with NaCl-HCl .....	41
38	Flowsheet for on-site testing .....	47



---

## Tables

1	Magnitude of the Physical Properties for the Two-Component Soil Systems .....	2
2	Radon Test Results for the Soil Washing Laboratory .....	9
3	Size Analysis of the Ra-Contaminated Ottawa Site Soil Sample .....	11
4	Settling Time for a Given Height as a Function of Particle Size .....	13
5	Sedimentation Particle Size Analysis of -400 Mesh Ottawa Soil .....	13
6	Size/Ra-226 Activity Analysis of the Ra-Contaminated Ottawa Site Soil Sample .....	13
7	Size/Gross-Activity Analysis of the Ra-Contaminated Ottawa Site Soil Sample .....	15
8	Radium Separation Accounting Data for -100 Mesh Ottawa Soil Sample by Flotation with Aero R-801 Analyzed by Thermo NUtech .....	24
9	Radium Separation Accounting Data for -100 Mesh Ottawa Soil Sample by Flotation with Sodium Lauryl Sulfonate Analyzed by Gas Proportional Counter .....	24
10	Radium Separation Accounting Data for -100 Mesh Flotation Tail Sample by Magnetic Separation Analyzed by Gas Proportional Counter .....	25
11	Radium Separation Accounting Data for -100 Mesh Ottawa Soil Sample by Flotation at High pH .....	26
12	Radium Separation Accounting Data for -100 Mesh Ottawa Soil Sample after Having Undergone Attrition Scrubbing .....	27
13	Radium Separation Accounting Data for -100 Mesh Ottawa Soil Sample after Having Undergone Ultrasonic Pretreatment .....	28
14	Radium Separation Accounting Data for -50 Mesh +10 Micron Ottawa Soil Sample by Flotation .....	29
15	Gross Activity Separation Accounting Data for 300 x 10 Micron Ottawa Soil Sample by Hot Water Flotation at 32°C .....	30
16	Gross Activity Separation Accounting Data for 300 x 10 Micron Ottawa Soil Sample by Flotation at High Dosage of R-801 .....	31
17	Gross Activity Separation Accounting Data for 300 x 10 Micron Ottawa Soil Sample by Flotation at High Dosage of 8-HQ .....	32
18	Gross Activity Separation Accounting Data for 300 x 10 Micron Ottawa Soil Sample by Flotation at High Dosage of Cupferron .....	32
19	Gross Activity Separation Accounting Data for 300 x 10 Micron Ottawa Soil Sample by Flotation by Combining 8-HQ with R-801 .....	33
20	Ra-226 Separation Accounting Data for 300 x 10 Micron Ottawa Soil Sample by Flotation by Combining 8-HQ with R-801 .....	33
21	Radium Decontamination Data by Salt Solution Washing for -30+50 Mesh Ottawa Soil .....	35
22	Gross Activity Decontamination Data by High-Concentration Salt Solution Washing for -30 +50 Mesh Ottawa Soil .....	36
23	Gross Activity Decontamination Data by Low Concentration Salt Solution Washing for 300 x 10 Micron Ottawa Soil .....	37

---

24	Ra-226 Activity Decontamination Data by Low Concentration Salt Solution Washing for 300 x 10 Micron Ottawa Soil .....	37
25	Gross Activity Decontamination Data by Low Concentration Salt Solution Washing for -5 +50 Mesh Ottawa Soil .....	38
26	Ra-226 Decontamination Data by High-Concentration Salt Solution Washing for -30+50 Mesh Ottawa Soil .....	38
27	Gross Activity Decontamination Data by Washing for -10 Micron Ottawa Soil .....	39
28	Ra-226 Activity Decontamination Data by Washing for -10 Micron Ottawa Soil .....	39
29	Gross Activity Decontamination Data by Washing/Sieving for -5 +50 Mesh Ottawa Soil .....	39
30	Gross Activity Decontamination Data by Two-Stage Washing for -5 +50 Mesh Ottawa Soil .....	40
31	Gross Activity Decontamination Data by One-Stage Extended Washing/Sieving for -5 +50 Mesh Ottawa Soil .....	41
32	Ra-226 Decontamination Data by One-Stage Extended Washing/Sieving for -5 +50 Mesh Ottawa Soil .....	41
33	Coating Tests Data for Using -5 Micron Ottawa Soil .....	42
34	Coating Tests Data for Using -5 Micron Ottawa Soil .....	42
35	Coating Test Results of -5 Micron Ottawa Soil with Quick Lime (0.3 M) .....	42
36	Coating Tests Results of -5 Micron Ottawa Soil with Calcium Hydroxide (10 gm/L) ...	42
37	Coating Tests Results of -5 Micron Ottawa Soil with Calcium Hydroxide (150 gm/L) .	43
38	Coating Tests Results of -5 Micron Ottawa Soil with Calcium Hydroxide and Sodium Phosphate (10 gm/L) .....	43

---

## **Acknowledgments**

The University of Nevada, Reno acknowledges the financial support for the project provided by the United States Environmental Protection Agency through its Office of Research and Development, National Risk Management Research Laboratory, Subsurface Protection and Remediation Division, Ada, Oklahoma. We are grateful to Dr. Mary Gonsoulin, EPA Project Officer, for her constant encouragement and continued support throughout this project. Finally, support provided by Mr. Larry Jensen and Mr. Matt Mankowski of U.S. EPA, Region 5, and Mr. Richard H. Mehl, Jr. of Roy F. Weston, Inc. is acknowledged.

---

# 1. Introduction

## 1.1 Background and Objective

The U.S. Environmental Protection Agency (U.S. EPA) is actively involved, through the Comprehensive Environmental Response, Compensation and Liability Act (CERCLA), in clean-up programs at radioactively contaminated sites. Generally, the contaminants are the naturally occurring radionuclides of uranium and the thorium decay series. Radium is often the primary contaminant of concern. The sites contaminated with radionuclides can be classified into two broad categories:

1. Government sites which are contaminated due to defense and weapons related testing programs (Johnston Atoll, Fernald, Hanford, Savannah and several others).
2. Residential and commercial sites which are contaminated due to industrial operations (e.g., Ottawa and Kerr-McGee sites in Illinois and several other CERCLA sites).

The radionuclides found in the soils of DOE and DoD sites are mainly uranium, thorium and plutonium, which are present either as particulates or adsorbed onto soils. On the other hand, the uranium and thorium sites may contain the entire chain or disrupted portions. If processed thorium has not been disturbed in 20 or so years it will be present in equilibrium in its series entirety. Common associated radionuclides are Ra-226, Ra-228, Rn-222 and its decay products, and Rn-220 and its decay products. The residential and commercial sites pose an immediate pollution threat and health hazard to the environment because of their proximity to the general public. For example, a Kerr-McGee residential area Superfund site (43 acres) is contaminated with Thorium-232 and possibly with Ra-228 (due to milling operations related to thorium and other rare earth materials which were used in the manufacture of filament coatings, polishing compounds and other products). Similarly, the soil of the Ottawa site in Illinois is contaminated with Radium-226 due to instrumentation and watch dial painting operations in the past.

The purpose of this research project was to undertake a bench scale study to remove radium from the contaminated soils of the Ottawa site. The remediation method sought had to be different from the direct soil excavation and shipping method, and had to act as an alternative to soil sorting and segmented gate methods. The obvious choices were physical separation, chemical, biological and vitrification methods. The cost of soil treatment by chemical leaching and vitrification was not only cost prohibitive for the virgin soils, but produced an undesired secondary waste stream and therefore was unacceptable [1]. Intuitively, one would expect that the physical separation based volume reduction technologies (which have shown great promise and success to remediate uranium, plutonium and thorium contaminated soils of DOE and DoD sites [1-8]) should be used as a proving ground for removing the radium from soils as well. If needed, the atmospheric chloride leaching process could then be used as a finishing step to desorb the residual radium [9-10].

In that regard, the University of Nevada, Reno (UNR) has developed and demonstrated the commercial viability of these physical separation based volume reduction technologies to remove potential contaminants such as uranium, plutonium, and thorium. The studies have been done at both laboratory and field scale level [7-11]. One of the major advantages of UNR volume reduction technologies is that these technologies work as a treatment train and can be configured after characterizing the contaminant's association and distribution in soil. In the case of the Ottawa radium contaminated soil, this feature can be exploited by using a cascade of the technologies to clean the low activity areas (<20 pCi/gm); middle activity areas (greater than 20 pCi/gm but less than nanocuries/gm); and high activity areas (between nano and microcuries/gm). For example, screening and centrifugal gravity/gravomagnetic separation technology can be used to remove large particulates such as dial parts mixed with the soil; whereas, flotation technology can be used to remove radium (as radium sulfate irrespective of whether it is present either as particulate or adsorbed onto soil particles). Because of similarity in properties like barium sulfate, radium sulfate particulate can be floated using selective alkyl sulfonate as a collector in conjunction with fatty acids [12-15].

The cost of disposal of a large volume of contaminated soil in land disposal facilities (LDFs) is high. One such LDF is the Envirocare Facility which takes naturally occurring radioactive materials (NORM) at a much lower cost. However, any chemical treatment applied to the soil may make the disposal cost prohibitive. The overall objective is to reduce the cost

of waste disposal by reducing the volume of contaminated soil requiring disposal by application of commercially available mining technologies. The physical separation based volume reduction methods are robust, well proven, and have been used to handle a large volume of low-grade ores, which are in many ways analogous to low-level radioactively contaminated soils. We are convinced that these technologies can be used to remove radionuclides and other contaminants from soils. It is envisioned that UNR technologies will physically separate radium-contaminated Ottawa soil into the two fractions:

- i radium-enriched fraction; i.e., 10-20% of the original volume for disposal;
- ii clean soil fraction greater than 80% of the original volume.

Similarly, the tailings were targeted to remain enriched in the natural components necessary to support plant life, and thus would not require post-treatment.

## 1.2 Rationale

It has been documented that Ra-226 in the Ottawa soil is present as  $RaSO_4$ . The sulfate salt of radium is extremely insoluble at normal conditions and its solubility is around  $2 \times 10^{-8}$  gm/cc [16]. The obvious choice, therefore, will not be to dissolve the radium (because this will not only require stringent and controlled conditions, but will produce secondary waste). Our approach, therefore, will be to separate these insoluble sulfates of radium using the froth flotation approach. This is similar to what has been done in the earlier studies with regard to the separation of uranium, plutonium, and thorium from siliceous and calcareous minerals. The separation will result in a concentrate fraction predominantly enriched in radium. Following the flotation stages, if the soil does not result in the clean-up criteria (5 pCi/gm of Ra-226 over background), then the soil will be treated by an atmospheric oxidative chloride leaching step to desorb the residual radium. The residue from this atmospheric leaching step will be the clean soil ready for revegetation. The dissolved heavy metals and radium from the process water will be removed using a variety of adsorbents. The loaded adsorbents will be mixed with the radium enriched concentrate, which will be agglomerated, and macroencapsulated for the final disposal.

Physical/physico-chemical separation of soil is essentially a process of separating contaminated soil (feed) into heavier radionuclides/heavy metals-rich (concentrate) and lighter radionuclides/heavy metals-lean (tailings) fractions by virtue of the difference in physical properties of radionuclides/heavy metals in relation to the host soil matrix. The physical properties which are of interest are specific gravity, magnetic susceptibility, and surface activity. The physical separation processes utilizing these properties are gravity concentration, magnetic separation, and froth flotation. These processes have been traditionally used in the mineral industry to separate valuable minerals from waste minerals, relying on the difference in the magnitude of physical property of the two phases. One such example where the combination of these technologies is used is the rejection of ash-bearing minerals from coal. The fact that radionuclides/heavy metals are physically attached to soil particles and have physico-chemical properties different from soil makes the conventional mineral beneficiation technologies viable volume reduction processes of the future. **Table 1** lists the magnitude of difference in the physical properties of major radionuclides/soil systems [4]. Note that such differences in the physical properties of heavy metals and soils phases do exist, and therefore the concentration of both heavy metals/radionuclides is possible. For the purpose of comparison the properties of coal/ash minerals system are also listed and highlighted.

**Table 1.** Magnitude of the Physical Properties for the Two-Component Soil Systems

SYSTEM	PROCESSES		
	Gravity Separation (spec. gravity, g/cc)  [Low/High]	Magnetic Separation (vol. magnetic suscept., SI X 10 <sup>6</sup> ) [Dimag./Paramag.]	Flotation [Hydrophilic, Hydrophobic]
Soil/UO <sub>2</sub>	2.6 / 10.96	-14 / 1204	Hydrophilic/Hydrophobic
Soil/UO <sub>3</sub>	2.6 / 7.29	-14 / 41	Hydrophilic/Hydrophobic
Soil/U <sub>3</sub> O <sub>8</sub>	2.6 / 10.0	-14 / 107	Hydrophilic/Hydrophobic
Soil/PuO <sub>2</sub>	2.6 / 10.5	-14 / 384	Hydrophilic/Hydrophobic
Soil/ThO <sub>2</sub>	2.6 / 9.7	-14 / -7	Hydrophilic/Hydrophobic
Coal/Ash	1.3 / 4.6	-13 / 130	Hydrophobic/Hydrophilic



---

### **1.3 Scope**

The project was an experimental technology evaluation and test to determine feasibility to effectively and economically remove radium from soil. The soil contaminated with radium was provided by the U.S. EPA. The flotation technology equipment was used. All the tests were performed at the University of Nevada, Reno. Soil sample count analysis was done on a routine basis at UNR using the Scalar Ratemeter (Ludlum Model 2200) in the soil washing laboratory (SWL.) Only selected samples were sent to Thermo NUtech, Richmond, California, (a certified laboratory) for a radium-226 gamma scan (Ra-226 pCi/gm).



## 2. UNR Soil Washing Laboratory

### 2.1 Design

The soil washing laboratory (SWL) is the DOE supported facility located on the ground floor of the Laxalt Mineral Engineering Building of the University of Nevada, Reno (UNR) campus. The laboratory occupies approximately 1200 square feet. A plan view of the laboratory is shown in **Figure 1**. The laboratory is divided into four distinct sections: the access control room, the vestibule, the monitoring room, and the laboratory work area. Each section of the laboratory is designed in accordance with the State of Nevada Building Standards. Access to the laboratory (marked 1 and 2 in **Figure 1**) is accomplished using a card key system. The doors (marked 3 and 4 in **Figure 1**) are designed as emergency exits only and are not used as entries into the laboratory work area. In case of a power failure, the doors open. There are no drains in the lab and the use of water is limited and controlled. The entire laboratory has a concrete slab floor with epoxy paint covering and the walls are painted with epoxy paint. Heating, ventilation and air-conditioning (HVAC) for the laboratory are designed independent of the total building. A state-of-the-art water treatment system which treats the process water is housed in the lab.

The vestibule is 8.6 by 11 feet with two double doors and one single door: the main entrance from the hallway (marked 1 in **Figure 1**) is accessed through a card key system, the entrance from the vestibule (marked 4 in **Figure 1**) opens into the laboratory work area, and the other entrance from the vestibule (marked 5 in **Figure 1**) allows access to the monitoring room. Entrance from the hallway (marked 2 in **Figure 1**) is not for public access. Equipment and soil sample containers are moved in or out of the laboratory work area by a removable metal ramp through the door (marked 4 in **Figure 1**).

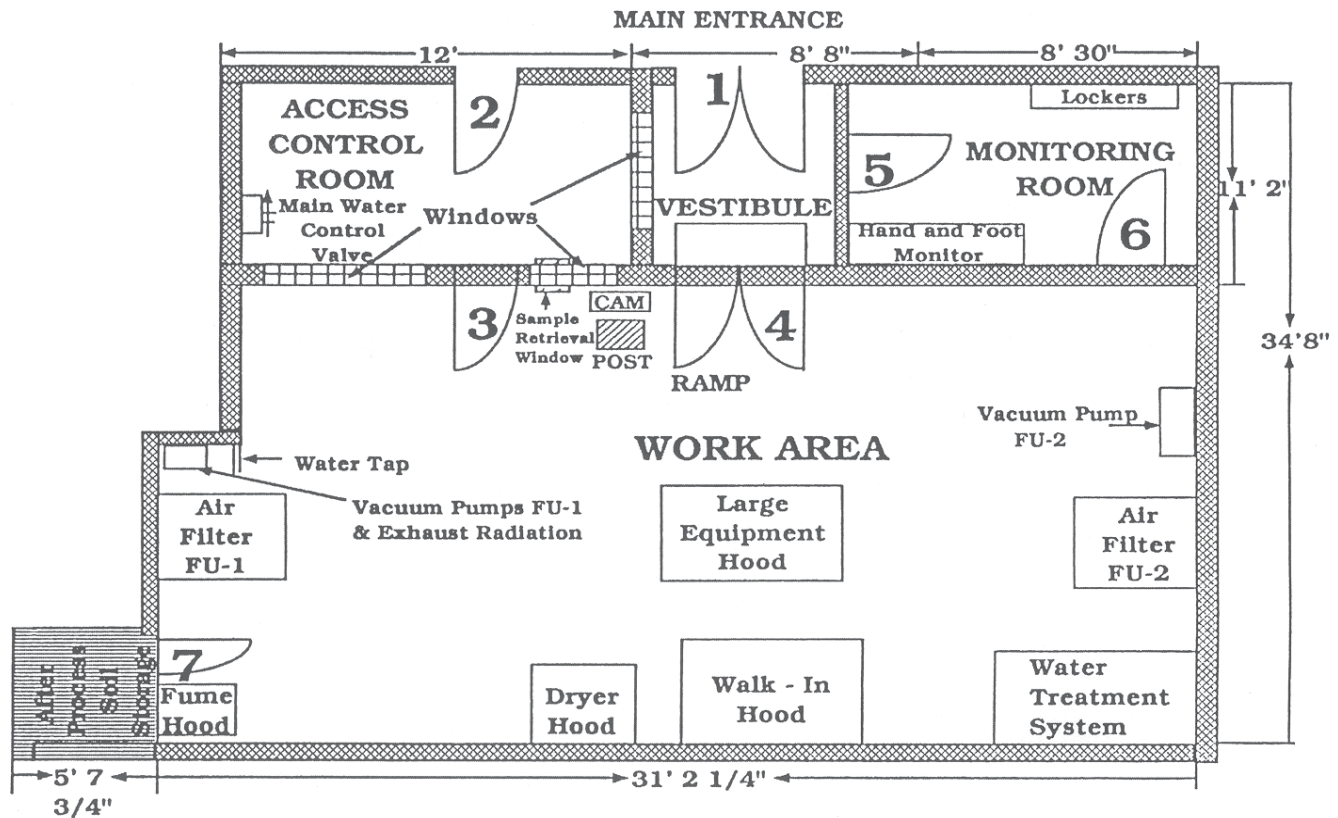

**Figure 1.** Schematic of soil washing laboratory.

---

The monitoring room has two single doors (marked 5 and 6 in **Figure 1**). This room has ten lockers and contains suit-up supplies such as Tyvek™ suits, pressurized air powered respirators (PAPRs), nitrile gloves, breathing air samplers, and other supplies. The monitoring room also has a hand-and-foot monitor (contamination monitor). Part of the monitoring room is used as a decontamination area.

The laboratory work area is approximately 1,000 square feet, and is divided into three distinct areas (water treatment system, the work area, and the after-process soil storage room).

The work area has two air filter units that supply clean air to the work area. Air cleaning is accomplished by the passage of air from the top to the bottom through three types of filters (six roughing filters on the top, six intermediate filters in between, and six HEPA filters on the bottom), which are arranged in series. These units ensure the air exhausting to the environment and recycled to the work area meets standards set by the U.S. Nuclear Regulatory Commission and the U.S. Environmental Protection Agency.

The work area is supplied with normal electrical utilities and contains one water source in the work area and an isolation valve in the access control room. Heating and air conditioning is provided through a heating and air conditioning unit controlled by a Johnson Controls monitoring system to ensure constant temperature. The work area has a dry carbon dioxide fire extinguisher, a first aid kit, and an eye wash kit.

Four hood systems are designed for the laboratory work area as shown in **Figure 1**, and consist of a walk-in hood, a dryer hood, a fume hood, and a large equipment hood. The fume hood is used for running tests of small technologies, and the large equipment hood is used for the testing of large technologies. These hoods are connected to the two air filter units.

New laboratory equipment, installed to support the studies, includes a state-of-the-art water treatment system designed by Culligan, Inc., two drying ovens, an alpha-beta continuous air monitor, a hand-and-foot monitor, two survey meters, a gas proportional counter, holding tanks, soil blenders, vibrating screens, filter presses, and an air compressor.

Each worker has to go through a series of trainings (radiation, HazMat, emergency response, hygiene, fit test, whole body counts, etc.) before being allowed to work in the SWL. The workers wear personal protective equipment (PPE) during soil testing such as pressurized air powered respirators, Tyvek™ suits, gloves, breathing sampler, and dosimeters.

The laboratory is controlled by a Johnson Controls monitoring system that is interfaced with a microcomputer and an on-line printer. This system ensures that all monitoring data is permanently stored. The system has a battery backup, flashing warning lights, and is designed to automatically shut down in emergencies. The system monitors the dust particles in high-efficiency particulate air (HEPA) filters; the radiation level of the air in the exhaust stack; the temperature of the work area and the access control room; the pressure difference of the work area against the access control room, the hallway against the vestibule, and the hallway against the access control room; and the airflow balancing in the work area. The system monitors the dust particles in the two air filters containing HEPA filters, the radiation level of the air in the exhaust stack and in the lab, the temperature and the pressure differences of the different areas of the lab. The system is designed to provide 4000 cfm of clean filtered air in the lab at all times. The system is configured such that any malfunction in any of the set point limits of the controlled variables will cause the flashing lights to activate. A diesel generator is connected to the air exhaust fan in the event of a power outage. The laboratory is operated in accordance with the OSHA requirements for the radiation protection of workers.

Should the parameters change in any of the areas, the monitoring system will automatically compensate for that change.

- i LOSS OF POWER: An uninterruptable power supply (UPS) provides power to the Johnson Controls system in the event of a power outage. This feature ensures security and access control of the doors and is essential to the operation of the exhaust fan powered by a back-up diesel generator. If the UPS battery is exhausted, the doors will open.
- i AIR FILTERS: The particulate concentration and the pressure drop in the two air filters are monitored. The particulate concentration in the filters is correlated with the pressure drop across the filter. In the event that either the pressure drop or particulate concentration exceeds set point values in any filter unit, flashing lights activate, and the air filter in which the subject filters are installed, automatically shuts down.
- i RADIATION DETECTION IN THE EXHAUST STACK: The radiation level of the exhaust is monitored, and if the radiation level exceeds set point value, a flashing light activates, and the exhaust fan shuts down.
- i PRESSURE MONITORING: The control system monitors pressure differences among three areas: pressure between the access control room and the work area, pressure between the hallway and the vestibule, and pressure between the hallway and the access control room. It is ensured that the access control room maintains positive pressure as compared to the work area, the hallway maintains positive pressure as compared to the vestibule, and

the hallway maintains positive pressure as compared to the access control room. This monitoring ensures that the laboratory is maintained under negative pressure at all times.

- i AIRFLOW BALANCING: The monitoring system ensures the outflow of air from the exhaust is higher than the inflow of air through the air handler at all times to maintain the laboratory under negative pressure.
- i TEMPERATURE MONITORING: The monitoring system maintains the temperature of the access control room and the laboratory at the preset levels.
- i FIRE CONTROL: The smoke detector is installed adjacent to the air-handler system. If the detector activates, the air-handler system will shut down. In addition, there are nine water sprinklers in the work area and one sprinkler each in the soil storage room, the vestibule, the access control room, and the monitoring room. The work area is designed in such a way that it will contain all of the water in the lab even if all of the ten sprinklers activate simultaneously, and remain on at its rated capacity for 20 minutes until the fire department responds.

## 2.2 Operations

The pathways for handling and transporting soil and test samples are depicted in **Figure 2**. **Figures 3 and 4** show the paths taken by occupational workers under normal and emergency situations for entering and exiting the SWL.

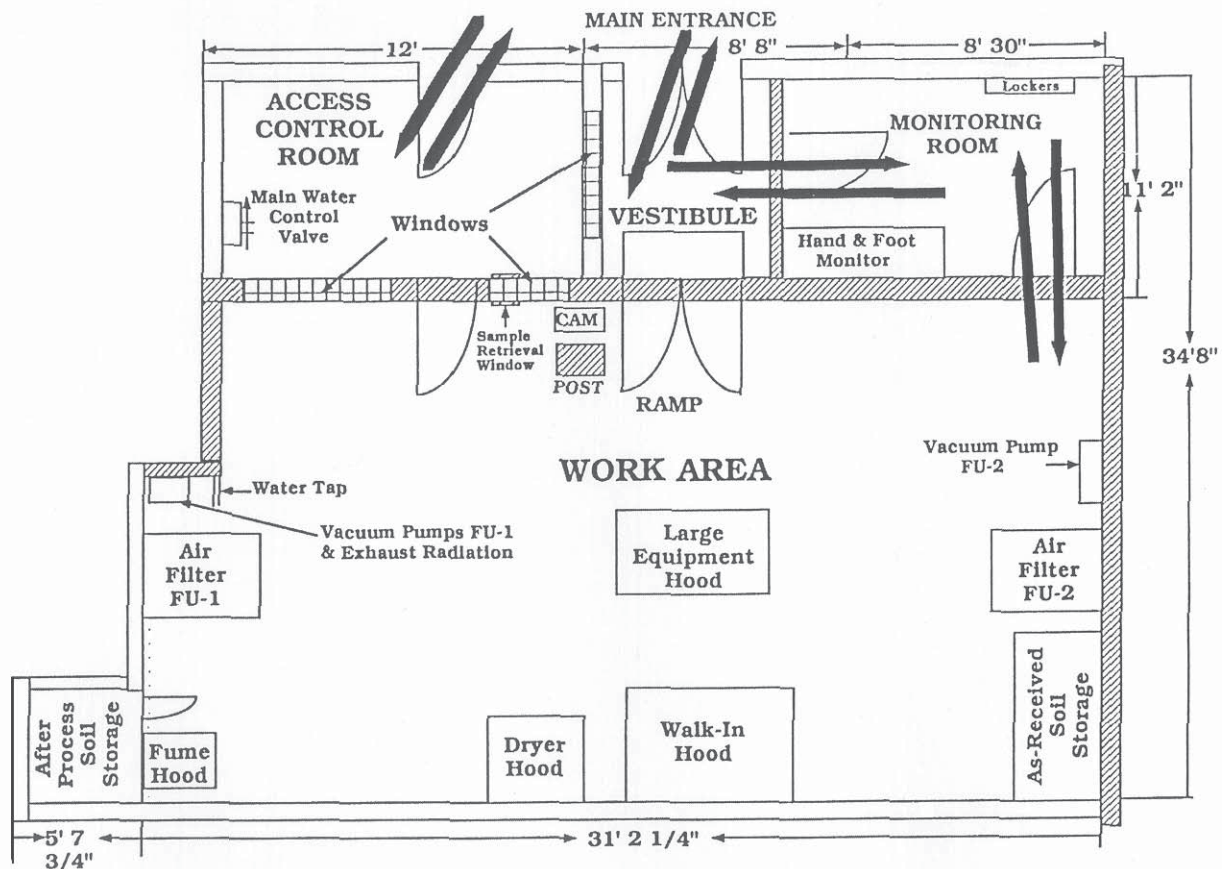

**Figure 2.** Soil washing laboratory - personnel movement.

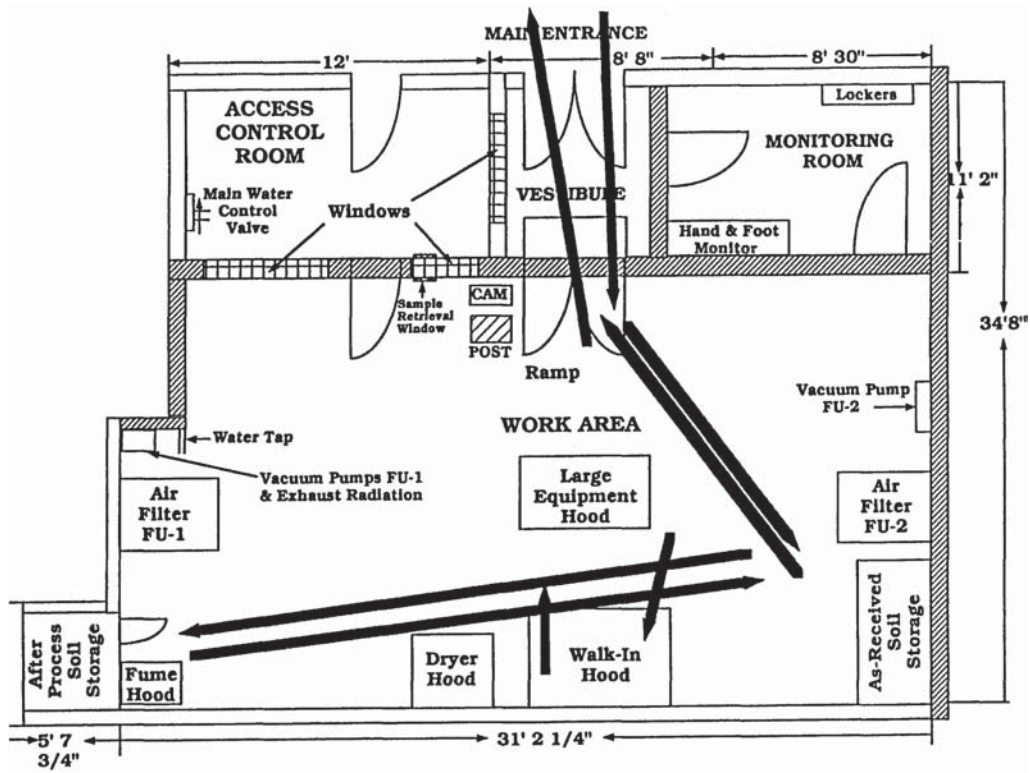

Figure 3. Soil washing laboratory - soil movement.

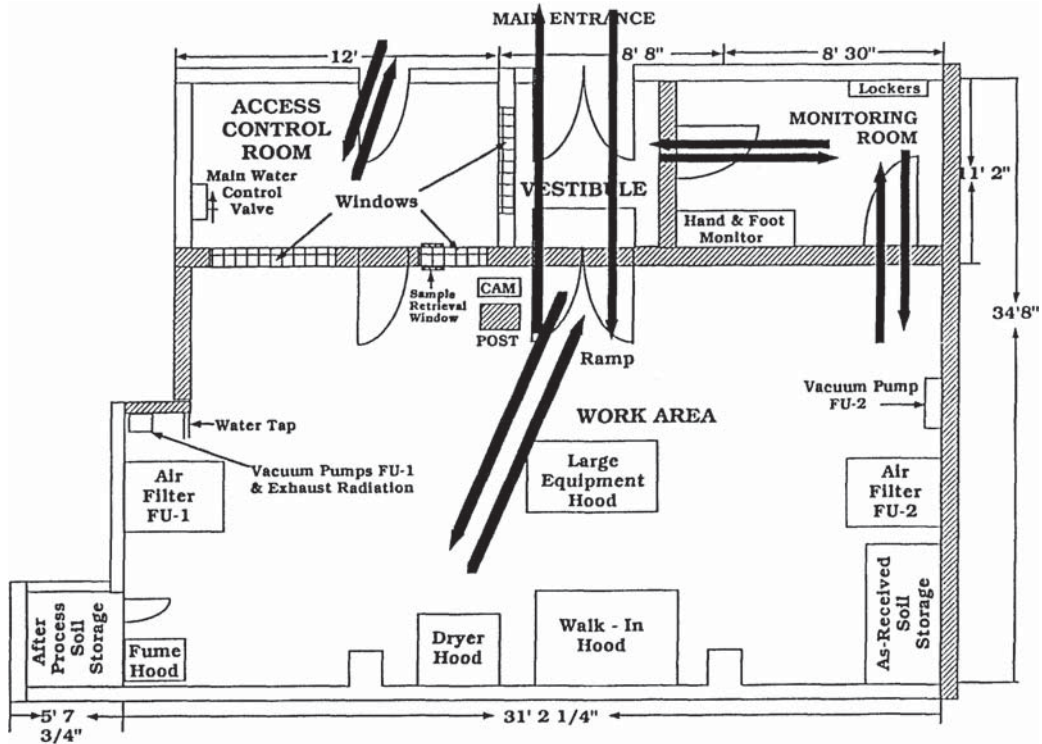

Figure 4. Soil washing laboratory - evacuation routes.

## 2.3 Acquisition of Soil and Laboratory Readiness

The radium-contaminated soil sample used in the test work was supplied by R. F. Weston, Inc., 3 Hawthorn Parkway, Vernon Hills, Illinois 60061. The soil used in this study was contaminated as a result of the watch dial painting operations. A 55-gallon drum weighing 350 lbs. containing Ottawa soil in the sludge form was received in April 1998. The drum was surveyed for surface radiation, which revealed no radiation leakage. It was first surveyed for radiation levels and radon concentration inside of the 55-gallon barrel. Radiation levels were about 0.5 mR/hr in contact to the barrel. The radon concentration level inside of the sealed barrel was estimated at about 238 pCi/L. The barrel was about one third full. It was then stored in the storeroom in the SWL and sampled for the tests. The SWL was surveyed for background radon counts. For this purpose, radon content of four different areas of the laboratory was measured. Results indicated that the radon levels were well below 4 pCi/L. The results were analyzed by Alpha Spectra, Inc., Grand Junction, Colorado, and are briefly summarized in **Table 2**.

**Table 2.** Radon Test Results for the Soil Washing Laboratory

SWL Location	Measured Radon Level (pCi/L)
Access Control Room	1.7
Suit-up Room	1.0
Walk In Hood	0.3
Soil Storage Room	0.2

## 2.4 Performance Criterion

The objective of the soil washing research activities was to undertake a treatability study and test to determine the feasibility of removing radium from soil by using commercially available physical beneficiation technology. The performance criterion was targeted to produce at least 80% of the activity recovery in 20% or less of the original contaminated soil volume.

It was decided to conduct the separation analysis not in terms of the final activity of the soil, but rather in terms of two parameters, namely the "activity separation efficiency," and the "weight reduction efficiency or volume reduction factor." The "activity," unless otherwise mentioned, refers to the gross alpha activity (pCi/gm). The volume reduction criterion is considered to be satisfied provided the activity separation efficiency is obtained beyond the "threshold" value (80%). The "concentrate" and "tailings" mentioned herein are referred to as the radium-enriched and radium-lean fractions.

The parameters were calculated as follows:

$$\text{Activity Separation Efficiency (\%)} = \frac{(\text{Concentrate wt}) (\text{Gross alpha activity in concentrate})}{(\text{Feed soil wt}) (\text{Gross alpha activity in feed soil})} \times 100$$

$$\text{Weight Reduction Efficiency or Volume Reduction Factor, (\%)} = \frac{\text{Tailings weight}}{\text{Feed soil weight}} \times 100$$





## 3. Soil Sample Characterization

### 3.1 Characterization of the Ra-Contaminated Ottawa Site Soil Sample

#### ***Blending, Homogenization and Particle Size Analysis***

A 55-gallon drum weighing 350 lbs. with soil in the form of sludge from the Ottawa site was received. A representative soil sample was wet-sieved on 200-mesh screen. The oversize material (+200 mesh fraction) was dried and the dried material was screened. The undersize material (-200 mesh fraction) was screened on 400 mesh screen which resulted into -200+400 mesh and -400 mesh fractions. About 2 kg soil sample was first wet-sieved into -400 (38  $\mu\text{m}$ ) and +400 mesh sized fractions. The -400 mesh was classified into -38+10  $\mu\text{m}$ , -10+5  $\mu\text{m}$ , and -5  $\mu\text{m}$  with the sedimentation method as mentioned above. The +400 mesh size fraction was dried under a low-temperature heater (below 50°C) and then screened into several size fractions. All the size fractions were weighed and sampled to analyze the gross and accurate activity.

The size distribution data is listed in **Table 3** and plotted in **Figure 5**. From the size analysis data, it was observed that almost 50% of the soil was coarser than 100 mesh and 50% was finer than 100 mesh. The soil fraction coarser than 100 mesh was more or less equally distributed into coarse fractions, however, a significant portion of soil finer than 100 mesh was mainly concentrated into the less than 5 micron size range. The -400 mesh fraction was sized using the sedimentation technique on the basis of Stokes' Law and the detailed procedure is given below.

**Table 3.** Size Analysis of the Ra-Contaminated Ottawa Site Soil Sample

Mesh	Size (micron)	Weight %
+12	+1700	20.45
-12 +30	-1700+600	6.84
-30 +50	-600+300	15.55
-50 + 100	-300+150	10.70
-100 + 200	-150+74	4.69
-200 + 400	-74+38	7.69
subsieve	-38 +10	9.49
subsieve	-10+5	6.04
subsieve	-5	18.55

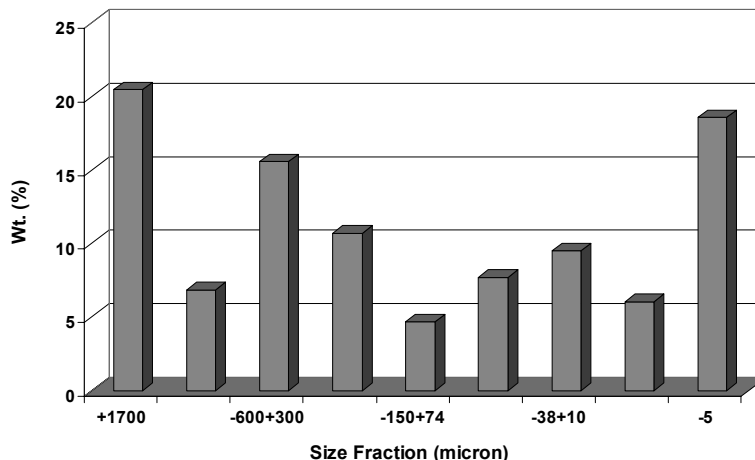

**Figure 5.** Weight percent distribution in different size fractions.

SUB-SIEVE SIZE ANALYSIS: For the size analysis of -400 mesh fraction material size, the sedimentation method was used. The sedimentation method is based on the measurement of the rate of settling of the particles uniformly dispersed in a fluid, and the principle is well illustrated by the common laboratory method of "Beaker Decantation" (see **Figure 6**).

The material under test is uniformly dispersed in water contained in a beaker or similar parallel-sided vessel. A wetting agent (such as  $\text{Na}_2\text{SiO}_3$ ) was added to ensure complete dispersion of the particles. A syphon tube was immersed into the water to a depth of  $h$ , corresponding to about 90% the liquid depth  $L$ . The terminal velocity is given by the equation derived by Stokes, namely:

$$v = \frac{d^2 g (D_s - D_f)}{18 \eta}$$

where  $v$  is the terminal velocity of the particle (m/s),  $d$  is the particle diameter (m),  $g$  is the acceleration due to gravity (m/s),  $D_s$  is the particle density ( $\text{kg/m}^3$ ),  $D_f$  is the fluid density ( $\text{kg/m}^3$ ), and  $\eta$  is the fluid viscosity ( $\text{N s/m}^2$ );  $\eta = 0.001 \text{ N s/m}^2$  for water. The times required for different particles to settle from water level to the bottom of the syphon tube, the distance  $h$  are calculated ( $t = h/v$ ). Water was decanted approximately 10 times to obtain a clear water above the settled solids for each size fraction.

Five hundred (500) gm of -400 mesh soil was attrition scrubbed by adding 8 kg/ton of sodium silicate (4.0 gm) in 750 ml of water for 30 minutes. Subsequently, the slurry was diluted by adding 23750 ml of water and mixing was continued for another 10 minutes. The settling time for a given settling height (20 cm) for four different size particles was calculated by the Stokes' Law which is listed in **Table 4** along with other settling heights. Twenty (20) cm of solution was decanted for different time periods. The water was added with same height; 4 kg/ton of sodium silicate was added and mixed for 10 minutes. This procedure was repeated 4-6 times until the top solution was clear. The fractions collected were dried and weighed. The sedimentation results are listed in **Table 5**.

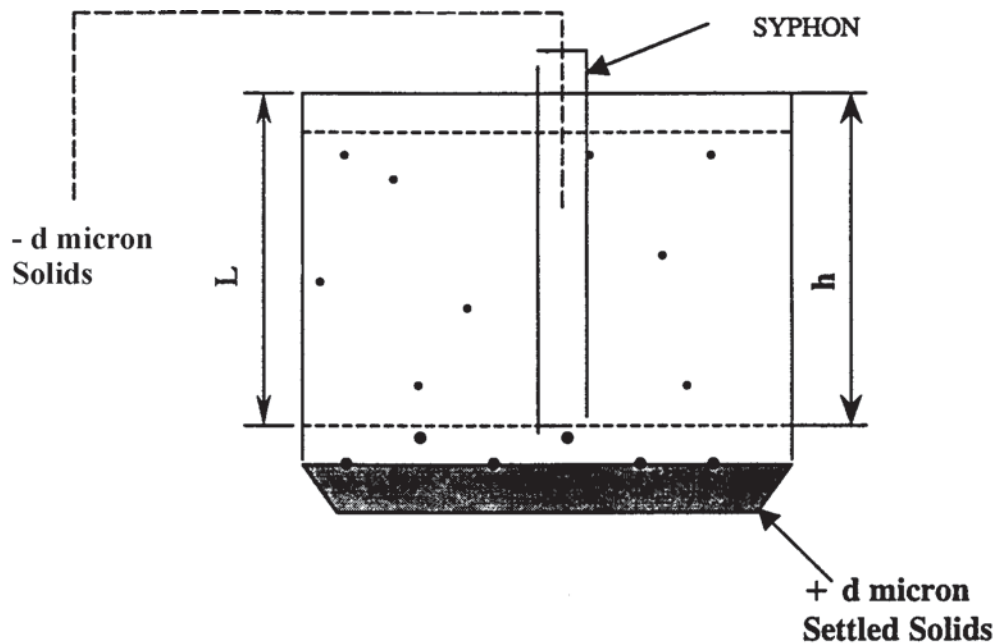

**Figure 6.** Schematic of vessel decantation.

**Table 4.** Settling Time for a Given Height as a Function of Particle Size

Settling Height, cm	Particle Diameter, Micron			
	5	10	20	30
20	11120 sec.	2224 sec.	556 sec.	247 sec.
25	13901 sec.	2780 sec.	695 sec.	309 sec.
30	16681 sec.	3336 sec.	834 sec.	371 sec.

**Table 5.** Sedimentation Particle Size Analysis of -400 Mesh Ottawa Soil

Size (micron)	Weight Percent (%)	Cumulative Percent (%)
-38 + 10	27.84	100.00
-10 + 5	17.72	72.16
-5	54.44	54.44

**pH Measurement**

Fifty (50) gm of -100 mesh soil was mixed in 100 cc of water and after two hours of mixing, the pH of the suspension was measured using a Fisher Acumet pH Meter. The pH was measured to be 6.92-7.2.

**Ra-226 Radioactivity Measurements by Gamma Spectroscopy**

The representative samples of soil from different soil size fractions were sent to Thermo NUtech for Ra-226 gamma scan. The size/Ra-226-activity analysis data are listed in **Table 6** and plotted in **Figures 7 and 8**. **Figure 7** shows the Ra-226 activity (pCi/gm) in individual size fractions, which clearly depicts the increase in Ra-226 activity with finer particle size. **Figure 8** shows that the Ra-226 activity distribution for particles coarser than 5 micron size is distributed in a narrow range of 4-12% and almost one-half of the Ra-226 activity is associated in less than 5 micron soil particles. This radioactivity/size analysis data indicates that the Ra-226 contamination is surface area related and is chemically bound to the soil particles. The average Ra-226 activity in the coarse +50 mesh fraction is 26.2 pCi/gm, which corresponds to 50% of the material. It is possible to screen and wash the +50 mesh fraction by mild salt solution to reduce the activity to permissible level.

**Table 6.** Size/Ra-226 Activity Analysis of the Ra-Contaminated Ottawa Site Soil Sample

Mesh	Size (micron)	Weight %	Ra-226 Activity (pCi/gm)	Ra-226 Activity Distribution (%)
+12	+1700	20.45	25.4	6.92
-12 +30	-1700+600	6.84	45.7	4.16
-30 +50	-600+300	15.55	18.8	3.89
-50 + 100	-300+150	10.70	33.4	4.76
-100 + 200	-150+74	4.69	75.1	4.69
-200 + 400	-74+38	7.69	114	11.67
Subsieve	-38 +10	9.49	93	11.75
Subsieve	-10+5	6.04	95.6	7.69
Subsieve	-5	18.55	180	44.47

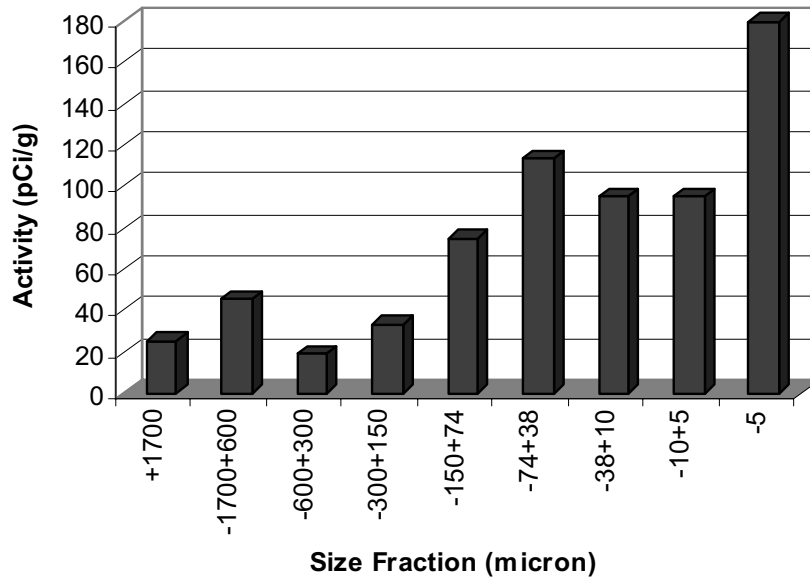

**Figure 7.** Ra-226 activity in different size fractions.

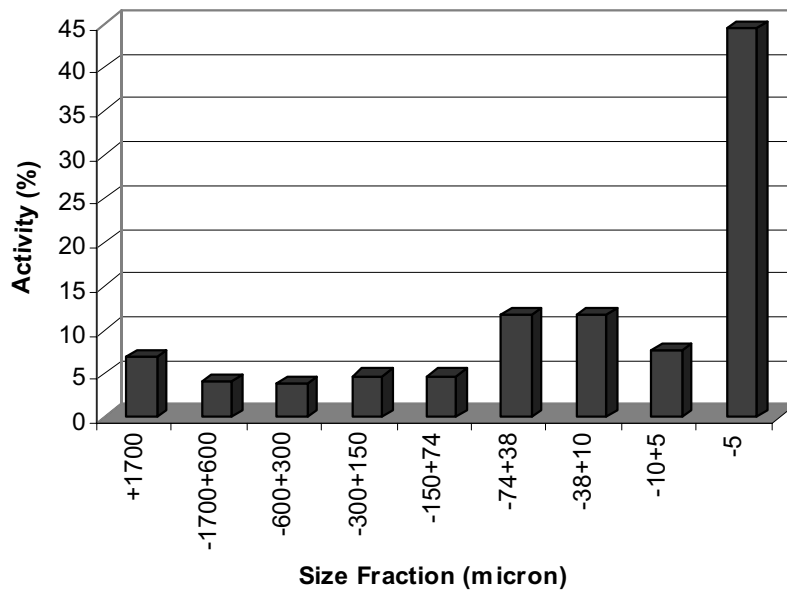

**Figure 8.** Ra-226 activity distribution in different size fractions.

### **Gross-Radioactivity Measurements by Gas Proportional Counter**

The same soil fractions sent to Thermo NUtech, Richmond, California, were also analyzed in the SWL using a gas proportional counter. This method gives an indication of the gross radioactivity present in the soil fraction. In this method, a small representative sample (1-2 gm) is spread on a planchet and counted for 2-5 minutes. The number of counts measured for a given duration gives a relative estimate of the radioactivity. The clean soil was also used to get an estimate of the background activity, which resulted in 6 counts for a 5-minute duration. The size/gross-activity analysis data is listed in **Table 7** and plotted in **Figures 9 and 10**. **Figure 9** shows the gross-activity (counts) in individual size fractions, which clearly depicts the increase in gross activity with finer particle size similar to the Ra-226 trend observed in **Figure 8**. **Figure 10** shows the gross-activity distribution which depicts that the gross activity is also uniformly distributed in all particle sizes. Almost one-half of the gross activity is associated in less than 5 micron soil particles similar to what was observed with respect to Ra-226 distribution. This gross-activity/size analysis data indicates that the in-house gas proportional method is an easy to use, inexpensive and time saving tool. Therefore, this method was used to analyze the results of routine experiments.

**Table 7.** Size/Gross-Activity Analysis of the Ra-Contaminated Ottawa Site Soil Sample

Mesh	Size (micron)	Weight %	Gross Activity (Counts*)	Gross-Activity Distribution (%)
+12	+1700	20.45	73	14.82
-12 +30	-1700+600	6.84	76	5.16
-30 +50	-600+300	15.55	70	10.81
-50 + 100	-300+150	10.70	49	5.20
-100 + 200	-150+74	4.69	98	4.56
-200 + 400	-74+38	7.69	94.5	7.21
Subsieve	-38 +10	9.49	79	7.44
Subsieve	-10+5	6.04	96	5.76
Subsieve	-5	18.55	212	39.04

\*Measured for 5-minute duration.

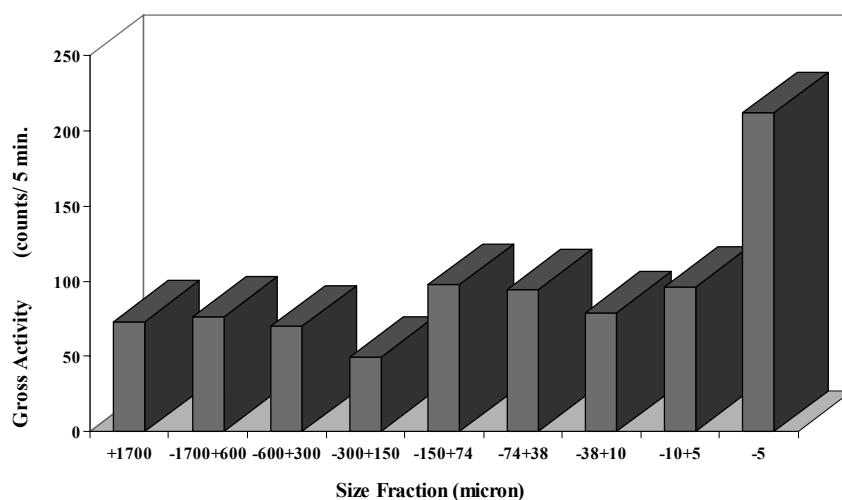

**Figure 9.** Gross activity in different size fractions.

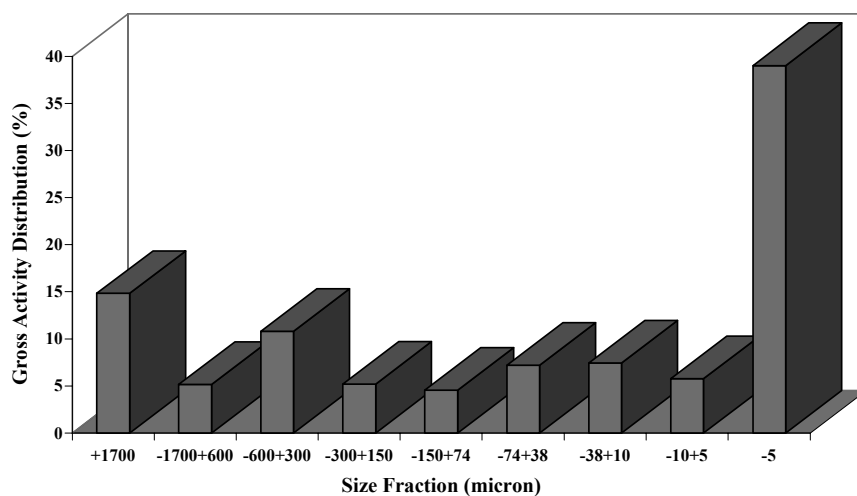

**Figure 10.** Gross-activity distribution in different size fractions.

Note that gross activity of the clean soil was measured to be 6 counts for a 5-minute duration.



---

## 4. Description of Mechanical Flotation Technology

Flotation is a physico-chemical process in which one constituent can selectively be separated from another on the basis of surface properties. This is achieved by controlled additions of chemical reagents at predetermined pH, thereby selectively altering the surface characteristics of radionuclide enriched particulates. This treatment renders soil particles contaminated with radionuclides as hydrophobic (water repellent). Phase separation is then followed by passing air through reagentized slurry. Air bubbles selectively attach to radionuclide enriched soil particles and are levitated to the surface in the form of froth. The separation of soil particles contaminated with radionuclides thus renders the remaining soil clean.

The automated mechanical cell, developed by the University of Nevada, Reno (UNR), is a modification of the Denver D-12 laboratory machine, which incorporates a 120 VAC adjustable, automated froth removal system and a controller to maintain constant pulp-froth interface. The modification to the Denver unit is the mounting of the main shaft. Upon the main support shaft, a 90-degree pivoting elbow with a keyed shaft is adjusted for height and rotated into operating position. Moving laterally on the keyed shaft is an adjustable speed motor with a two-blade froth removing paddle. Critical operational adjustments are made in the following ways:

1. Moving the motor housing laterally on the shaft to regulate clearance in the paddle-dam relationship without the need for any locking mechanism;
2. Moving the vertical collar pivot up or down to set the paddle depth into the froth.

For cleaning, the motor is stopped in a horizontal position with the paddles, the knob on the pivoting elbow is unlocked, and the entire motor assembly is swung out of the way. A stop pin in the pivot collar ensures perfect repositioning when the unit is swung back into place. A knob on the face of the motor housing provides both on-off and speed control, with greater range adjustment provided by a user-adjustable, internal trim pot. The froth collection system consists of a tapered bottom and inclined trough to collect heavy radionuclides. The pulp-froth interface level control is achieved by sensing the vertical position of a float in a sight glass by a proximity switch. The switch is connected to solenoid valves and flow regulators.

### Operating Variables

- ĩ Solids concentration (5-20%)
- ĩ Agitation speed (1500 -1800 rpm)
- ĩ Reagents dosage (0.5 - 2 lb/ton)
- ĩ Froth sweeping speed (slow, medium, fast)
- ĩ Bubble size (220 -1000 micron)

**Figure 11** shows schematically the technological approach for separation of heavy metals and radionuclides from contaminated soil.

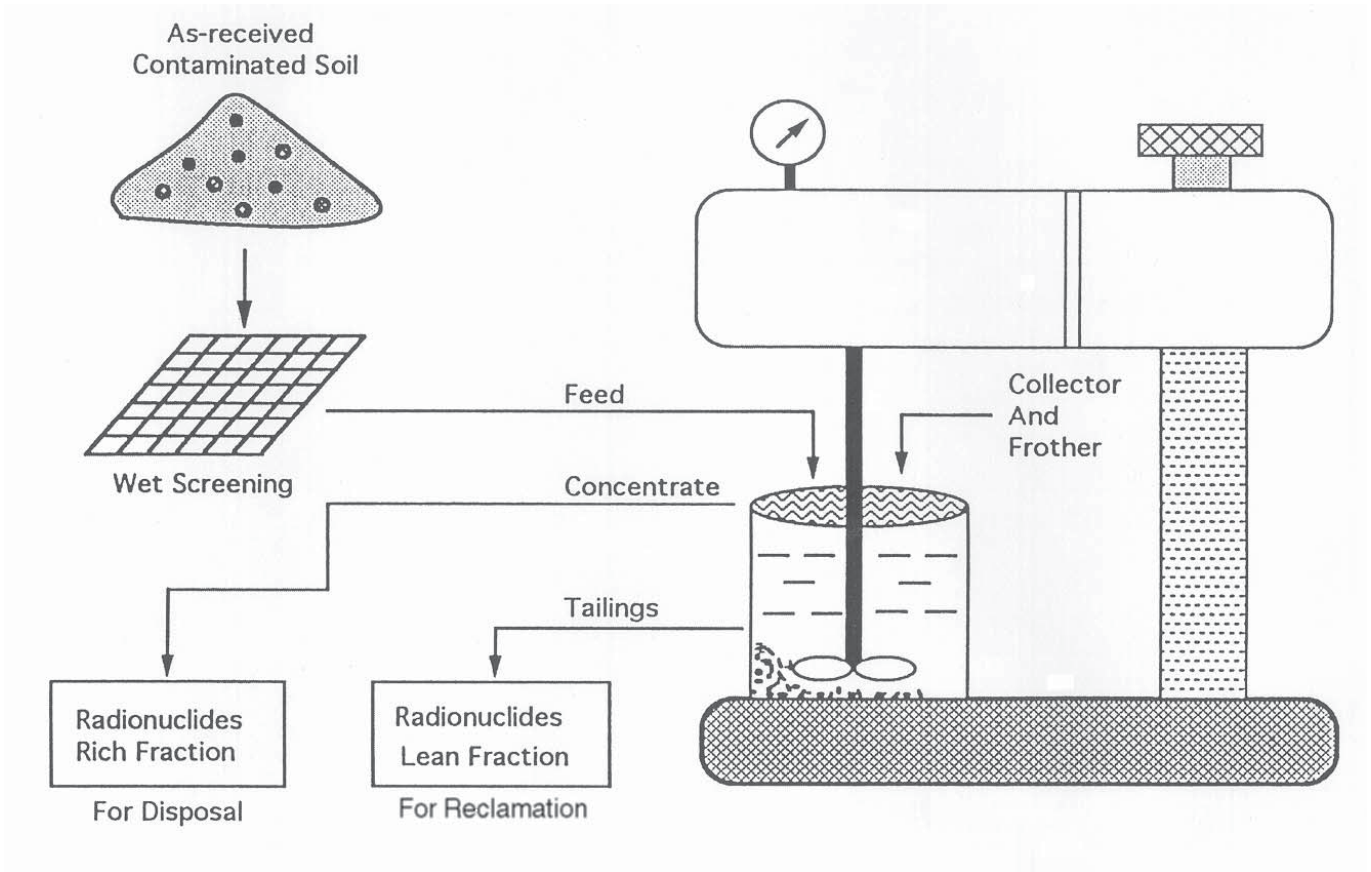

**Figure 11.** Technological approach for separation of heavy metals from soil.



---

## 5. Surrogate Testing

### 5.1 Surrogate Development

Flotation processes are based on the physico-chemical properties of the materials such as size, surface charge, and oxidation-reduction potential. It turns out that the contaminants are charged differently than the host soil matrix. Also, the chemical affinity (absorption) of these contaminants towards certain reagents is either electrical and/or chemical but selective. Therefore, the contaminants can be made hydrophobic, whereas the soil remains hydrophilic. The objective of this task was to find suitable surrogate materials having electrical and hydrophobic characteristics similar to those of the contaminants.

### 5.2 Surrogate Characterization

The objective was to prepare the appropriate size of the potential surrogates and measure the specific property of interest. Barite mineral (i.e., barium sulfate) was chosen to be a surrogate for Ra-226 present in the soil. This is because the physicochemical properties of barium and radium are quite similar. The surrogate material was subjected to the following characterization:

#### 5.2.1 Surface Charge Measurements

Zeta potential, an indicator of the surface charge on surrogate particles, was determined using the Laser Zee Meter. About 1 gm of -400 mesh surrogate sample was conditioned in  $1 \times 10^{-3}$  M  $\text{NaNO}_3$  for about 5 minutes. The pH was adjusted using NaOH and  $\text{HNO}_3$  and the sample was further conditioned for 5 minutes. Zeta potential values were then measured and the values reported here are the average of ten readings. **Figure 12** shows the effect of pH on the surface charge behavior of the barite mineral. The point of zero charge ("pzc") of barite is around pH 5-5.2. At pH above 5-5.2, the surface will be negatively charged, and below pH 5-5.2 the surface will be positively charged. Since the soil particles are also negatively charged above pH 5.2, surface active reagents (collectors) can be used which will selectively and preferentially bind barium sulfate particles and make them hydrophobic.

### 5.3 Hallimond Tube Flotation Experiments

Flotation of the surrogate, barium sulfate, as a function of pH and collector concentration was conducted using a Hallimond tube flotation cell. The objective of these experiments was to establish the optimum pH and collector dosage required for separation of surrogate barium sulfate from soil matrix. One gram of barium sulfate was conditioned in deionized distilled water for 5 minutes before pH adjustment was carried out. After pH adjustment, required amounts of sodium oleate were added and the sample was further conditioned for 5 minutes. The sample was then quickly transferred to the Hallimond tube and the airflow started at a rate of 60 cc/min. One drop of Dowfroth-250 (0.014 gm) was added. Flotation was carried out for about 4 minutes. The float and tailings were filtered, dried, weighed and the weight percent recovery was calculated. The schematic of the Hallimond flotation cell is given in **Figure 13**.

#### 5.3.1 Effect of Collector Concentration

In this series of tests, the concentrations of two reagents (sodium oleate and sodium lauryl sulfate) were evaluated. It was found that by increasing the concentration of the collectors, the recovery of barite was increased (see **Figure 14**).

#### 5.3.2 Effect of pH

The effect of pH was studied in the pH range of 2-12 by maintaining the collectors' concentration.  $1\text{E-}05\text{M}$  sodium lauryl sulfate showed increased recoveries from a value of 5% at pH 2 to 60% at pH 10 and decreased at high pH. This could be due to the precipitation of the sodium lauryl sulfate at high pH's. The results are plotted in **Figure 15**. Sodium oleate, on the other hand, did not show appreciable change in the recovery values in the pH range 2-12; and the recovery value was maintained at around the 80% level. These results are plotted in **Figure 16**. From these results it can be concluded that sodium oleate is an effective collector for recovering barite. On the other hand, lauryl sulfate is sensitive to the pH of the solution.

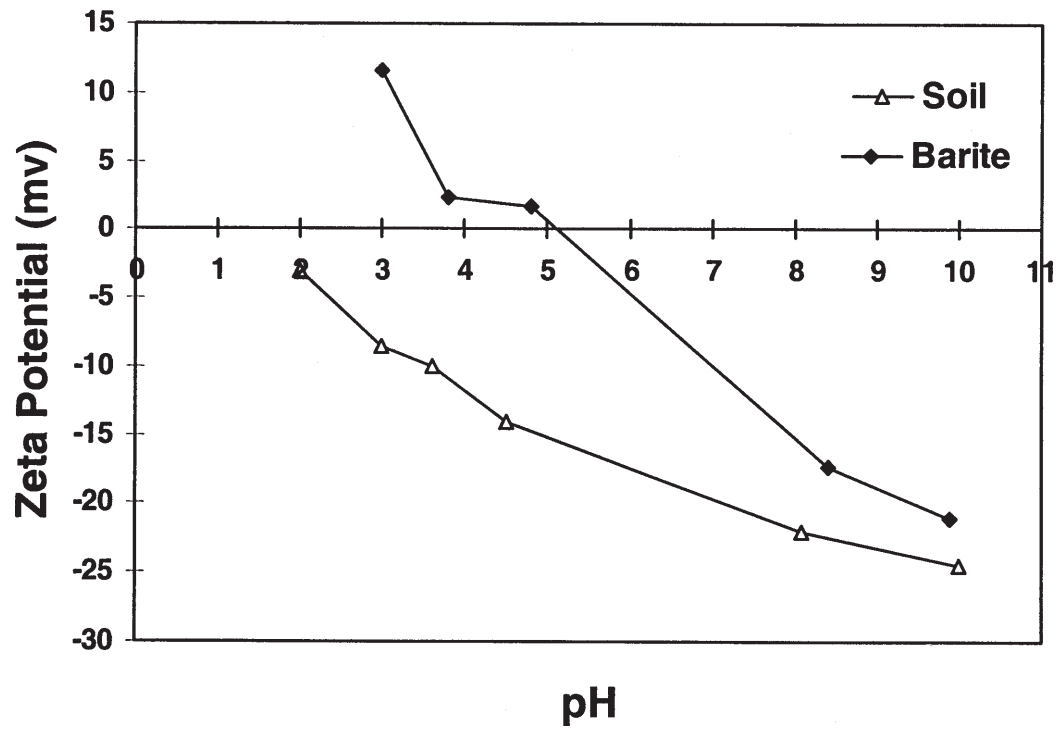

Figure 12. Effect of pH on zeta potentials of barite and soil.

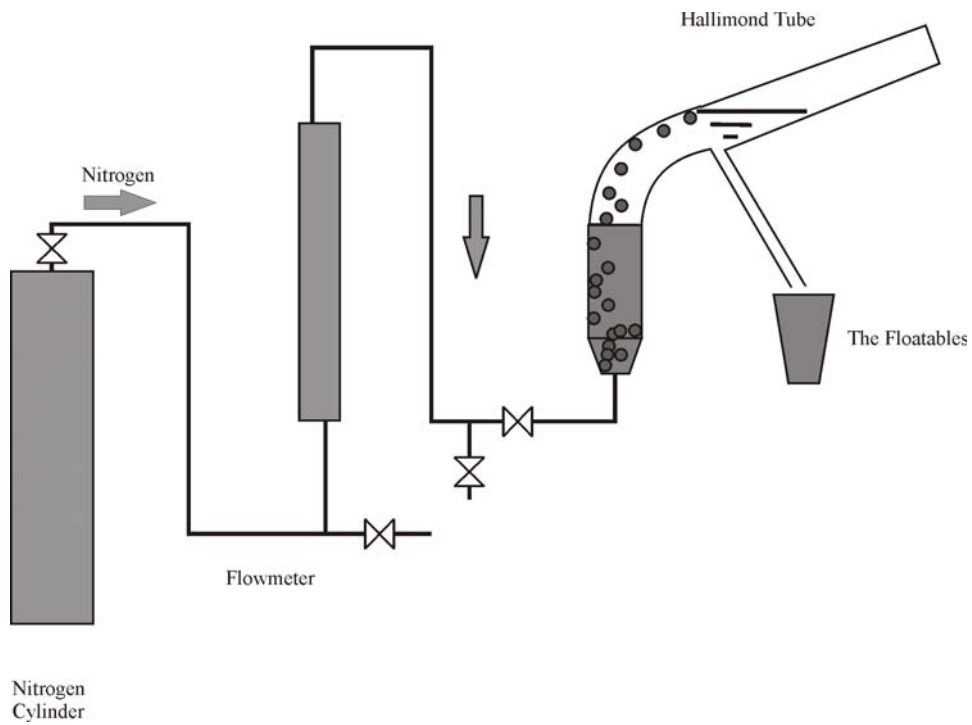

Figure 13. Schematic of the Hallimond tube flotation cell.

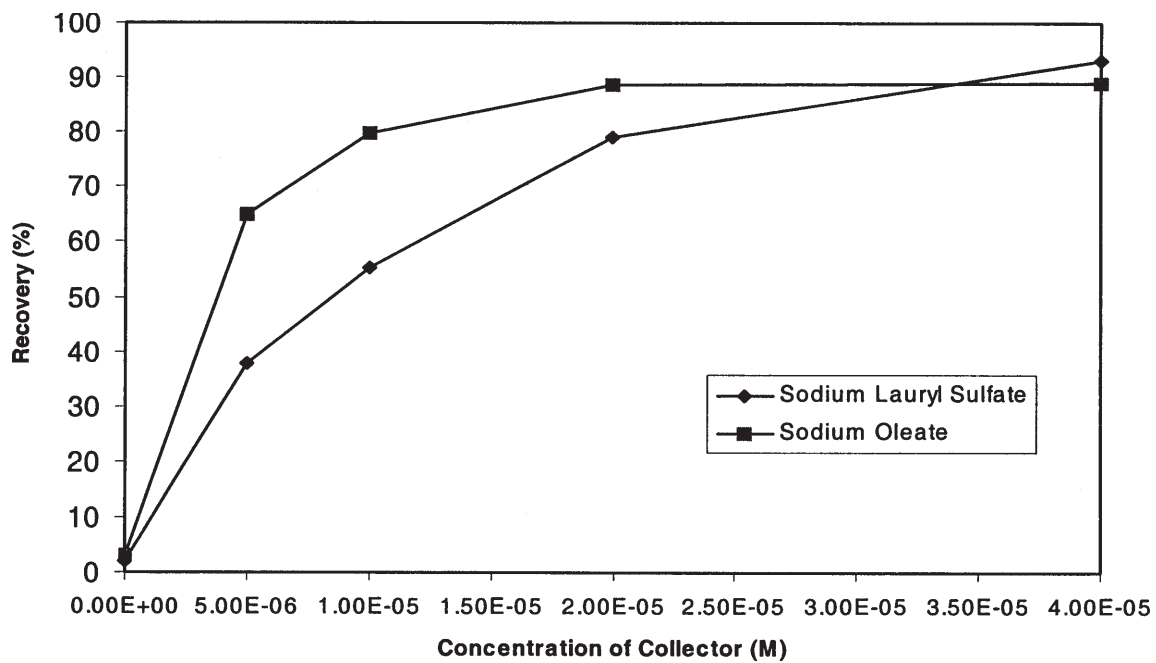

Figure 14. Effect of concentration of collector on barite flotation.

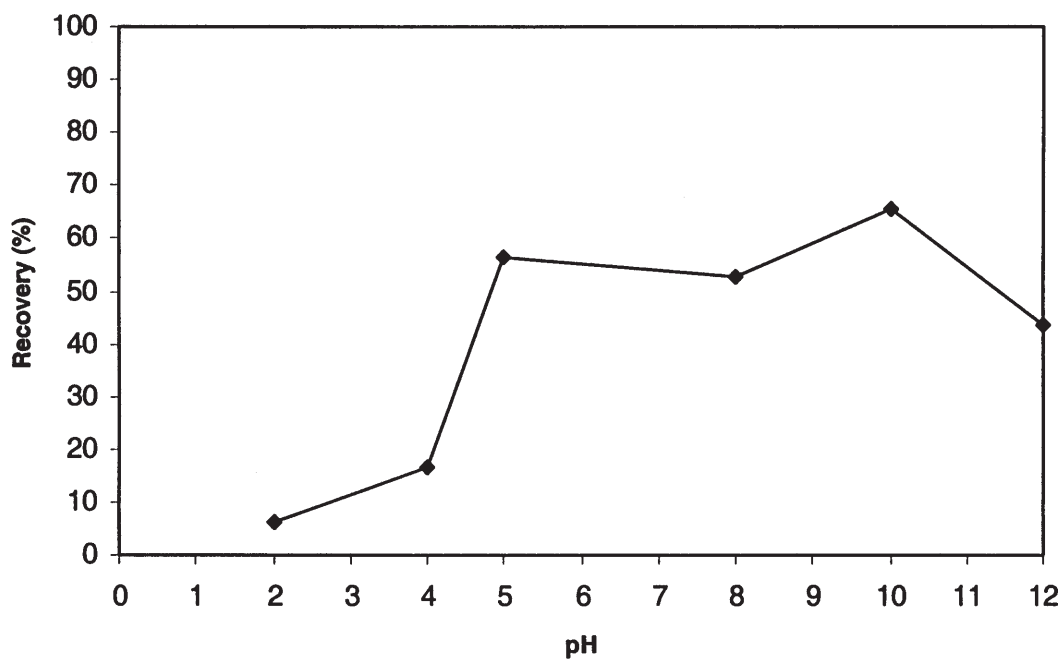
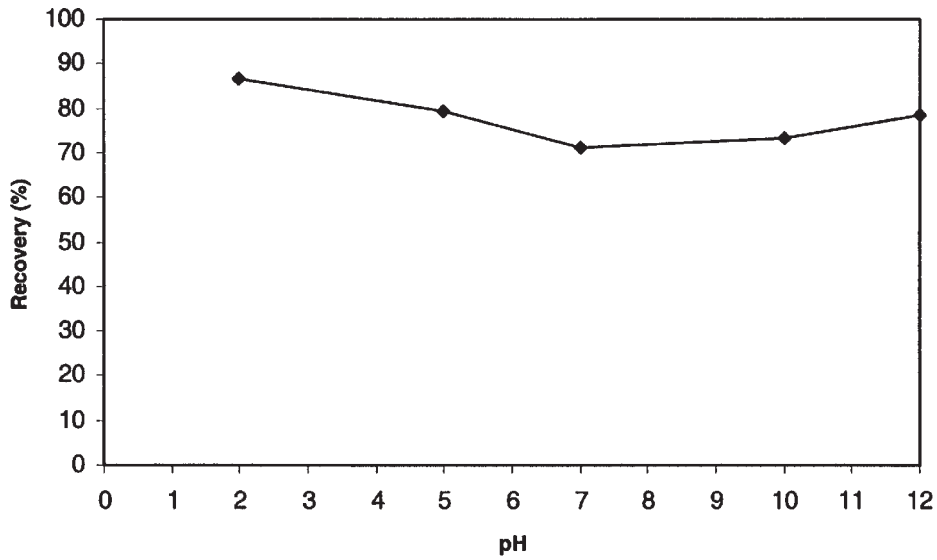

Figure 15. Effect of pH on barite flotation with sodium lauryl sulfate.



**Figure 16.** Effect of pH on barite flotation with sodium oleate.

### 5.3.3 Mixture of Soil and Barite

Flotation tests were conducted using a mixture of barite and soil. Results are given in **Figure 17**. As can be seen, more than 80% barite can be recovered from the soil/barite mixtures using oleic acid at pH 9.0. These results show that radium can be separated from the soil mixture.

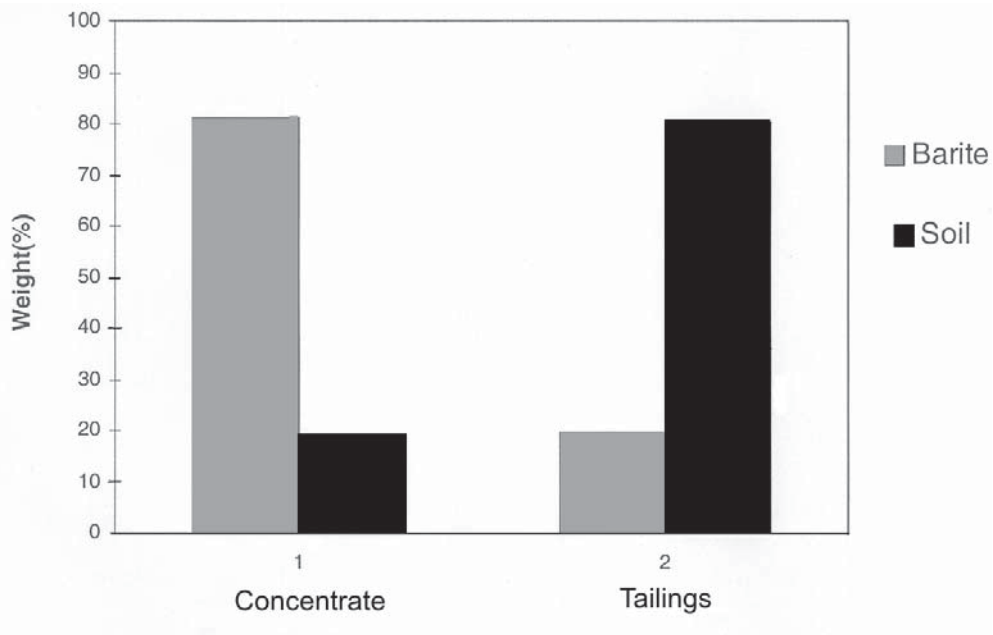
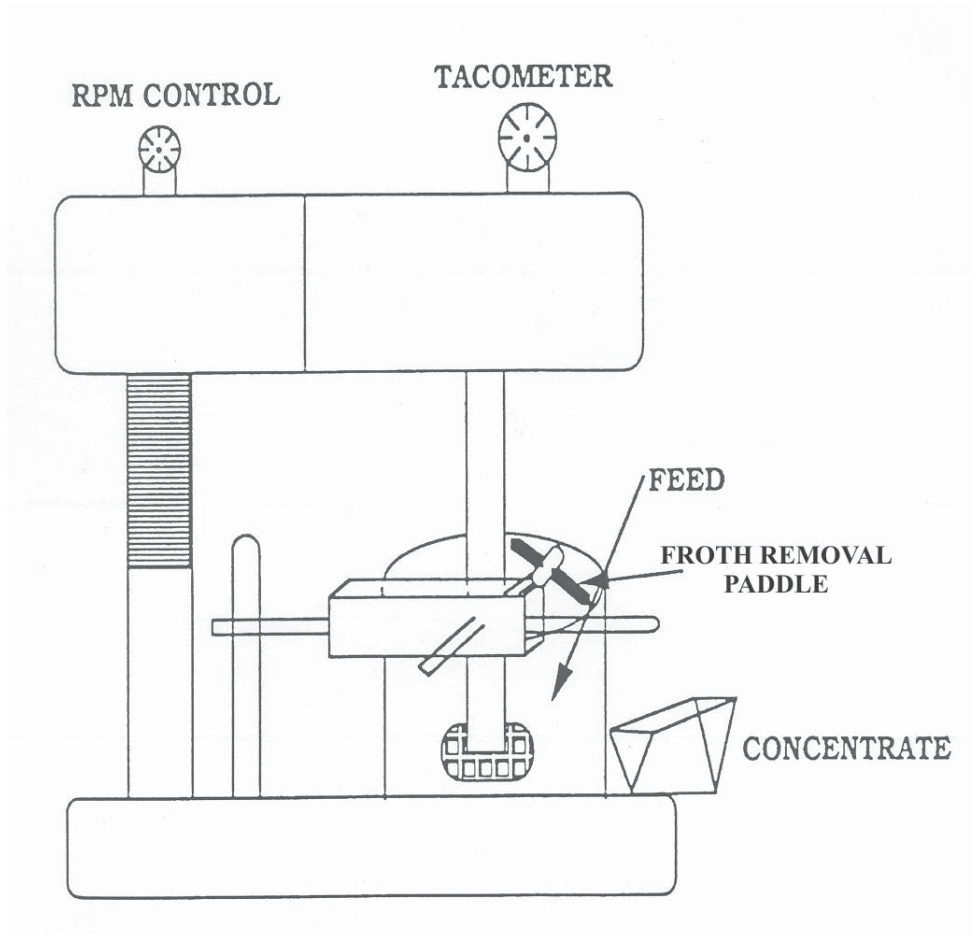

**Figure 17.** Selectivity test of barite and soil mixture.

## 6. Soil Testing

### 6.1 Flotation Tests Procedure

The representative feed sample weighing 100-250 gm used in each mechanical flotation test was attrition scrubbed at 1800 rpm and at 35-40% solids with sodium silicate for 5-10 minutes. The scrubbing was followed by conditioning with suitable dosages of collectors for 2-3 minutes. The water was added to make up the final slurry volume to 1 liter, and 2 drops of Dowfroth-250 was added. After 5 minutes, the rpm was reduced to 1000, and flotation was initiated by controlling the airflow rate. The flotation run time was 6-7 minutes depending upon the reagent's dosage level. The entire sample of the collected concentrate and the tail was dried and weighed. The concentrate and tailings collected from the sample were analyzed for the gross counts and Ra-226 activity. The schematic of the 1L Denver flotation cell is shown in **Figure 18**.



**Figure 18.** Schematic of automated mechanical cell.

## **Evaluation of Collectors at Natural pH**

In this category of experiments, three experiments were performed with -100 mesh soil fraction. One experiment was done with sodium lauryl sulfonate, one with Aero R-801, and one with sodium oleate. In each experiment, 250 gm of soil was pulped at 36% solids and blended by adding sodium silicate (4.0 kg/ton) for 3 minutes. The pH was adjusted in the range of 8.9-9.2 by adding sodium hydroxide. This was followed by adding a collector dosage of 0.333 kg/ton and conditioning was done for 2 minutes. Then the pulp was diluted at 9% solids and flotation was carried out at 1000 rpm for 6-7 minutes. The flowsheet of experimental procedure is shown in **Figure 19**. The results of a flotation experiment conducted with Aero R-801 and sodium lauryl sulfonate are provided in **Tables 8 and 9**.

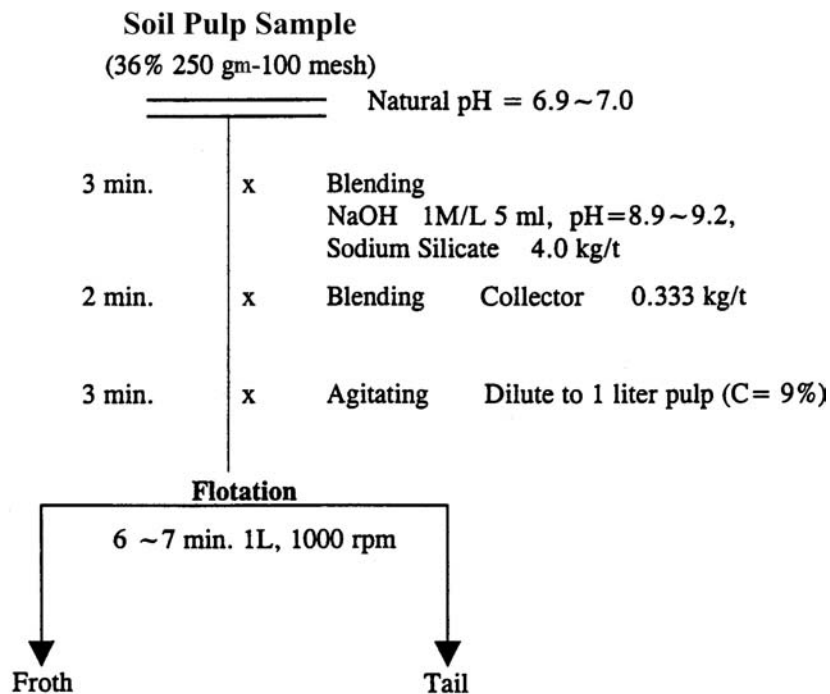

**Figure 19.** Flowsheet of experiment for flotation tests at natural pH.

**Table 8.** Radium Separation Accounting Data for -100 Mesh Ottawa Soil Sample by Flotation with Aero R-801 Analyzed by Thermo NUtech

Product	Weight (%)	Ra-226 Activity (pCi/gm)	Activity Distribution (%)
Concentrate	20.81	126	26.24
Tails	79.19	93.1	73.76

**Table 9.** Radium Separation Accounting Data for -100 Mesh Ottawa Soil Sample by Flotation with Sodium Lauryl Sulfonate Analyzed by Gas Proportional Counter

Product	Weight (%)	Ra-226 Activity (pCi/gm)	Activity Distribution (%)
Concentrate	17.09	94	17.40
Tails	82.91	92	82.60

From the preliminary data, it can be concluded that the Aero R-801 did show good selectivity and further improvement efforts were, therefore, continued. Due to extensive turnaround time taken by Thermo NUtech for the Ra-226 gamma scan, it was decided to analyze the samples for their gross activity by our in-house gas proportional counter. It was also decided to send selected samples for Ra-226 gamma scan, depending upon the results.

### **Magnetic Separation of Tails Product**

Assuming that the radium-enriched particles might be associated with iron bearing minerals present in the soil, magnetic separation of the tail product was, therefore, conducted. In order to confirm this point, 20 gm flotation tails collected in experiment 2 were tested at 10% solids. A magnetic block was immersed in the pulp for 3 minutes to remove magnetic particles. The experimental flowsheet is shown in **Figure 20**. The magnetic separation test results are listed in **Table 10**.

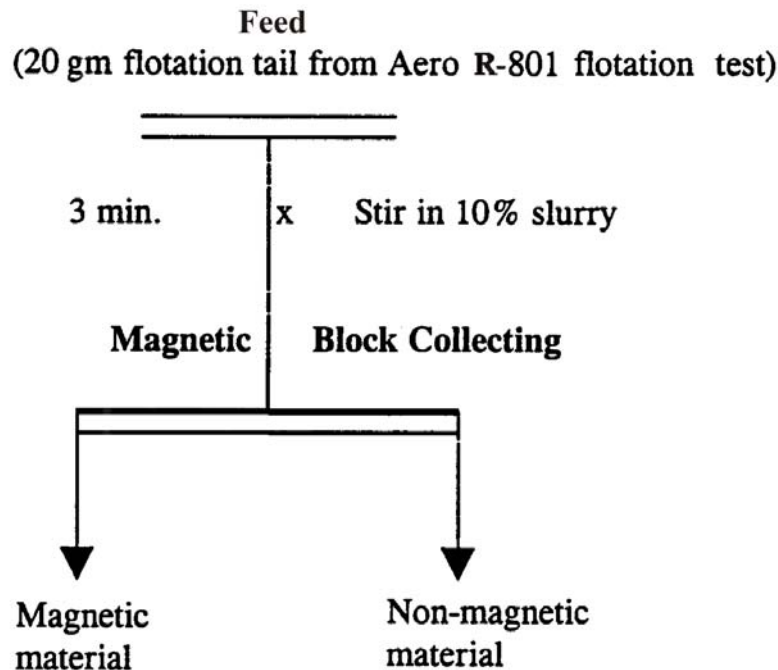

**Figure 20.** Flowsheet of experiment for magnetic separation of flotation tail.

**Table 10.** Radium Separation Accounting Data for -100 Mesh Flotation Tail Sample by Magnetic Separation Analyzed by Gas Proportional Counter

Product	Weight (g)	Wt. (%)	Activity (Counts/5 min.)	Activity (%)
Magnetic Mat.	1.21	6.05	108	6.34
Non- Mag. Mat.	18.79	93.95	102.7	93.66
Feed	20.00	100.00	103	100.00

The gross-activity counts showed that magnetic separation was not effective in producing the target results.

### **Flotation at High pH**

The solution pH can affect flotation response due to change in the zeta potential of the mineral particles. The experimental results show that barite flotation response improves with an increase in pH. Therefore, tests were conducted at high pH to see whether flotation of radium could be improved. About 100 gm of -100 mesh soil was blended for 5 minutes at high pH (11.2) by adding 20 cc of 1N NaOH. This was followed by conditioning for 5 minutes with collector dosage of 0.3 kg/ton and Dow frother addition of 0.015 kg/ton. Flotation was carried out for 10 minutes. The flowsheet is shown in **Figure 21**. The high pH flotation results are listed in **Table 11**. These results show that the collectors, unlike low pH, don't affect the separation at high pH.

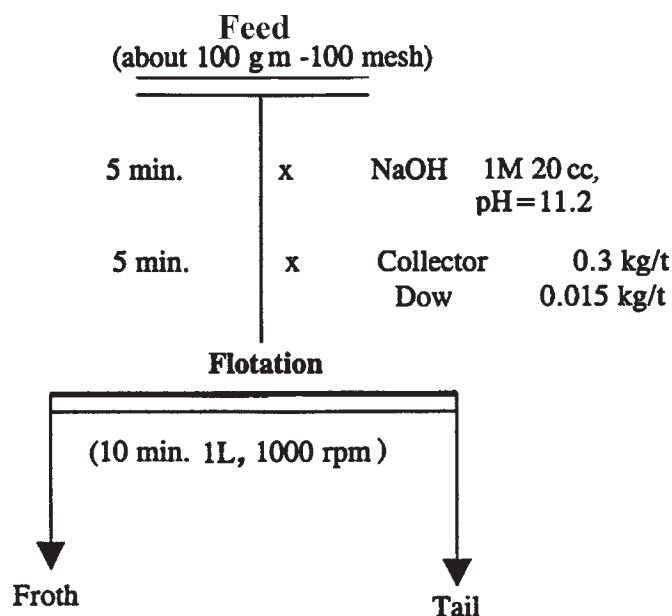

**Figure 21.** Flowsheet of experiment for flotation tests at high pH.

**Table 11.** Radium Separation Accounting Data for -100 Mesh Ottawa Soil Sample by Flotation at High pH

Collector	Product	Weight %	Gross-activity (Counts)*	Activity Distribution (%)
Sodium oleate	Concentrate	24.55	45.5	30.97
	Tails	75.45	33	69.03
Aero R-801	Concentrate	17.69	45.5	22.86
	Tails	82.31	33	77.14

### ***Effect of Attrition Scrubbing***

It was hypothesized that the radium containing particles are tightly bound with other siliceous particles. This would necessitate detachment prior to collector adsorption. Therefore, an experiment was carried out after an intense attrition scrubbing of the pulp. About 350 gm of -100 mesh soil was scrubbed at 36% solids for about 5 hours. This was followed by conditioning for 5 minutes with the collector Aero R-801 (0.3 kg/ton). Flotation was carried out for 10 minutes. The flowsheet is shown in **Figure 22**. The attrition scrubbing results are listed in **Table 12**. The attrition scrubbing showed breaking of the particles and no reduction in activity separation.



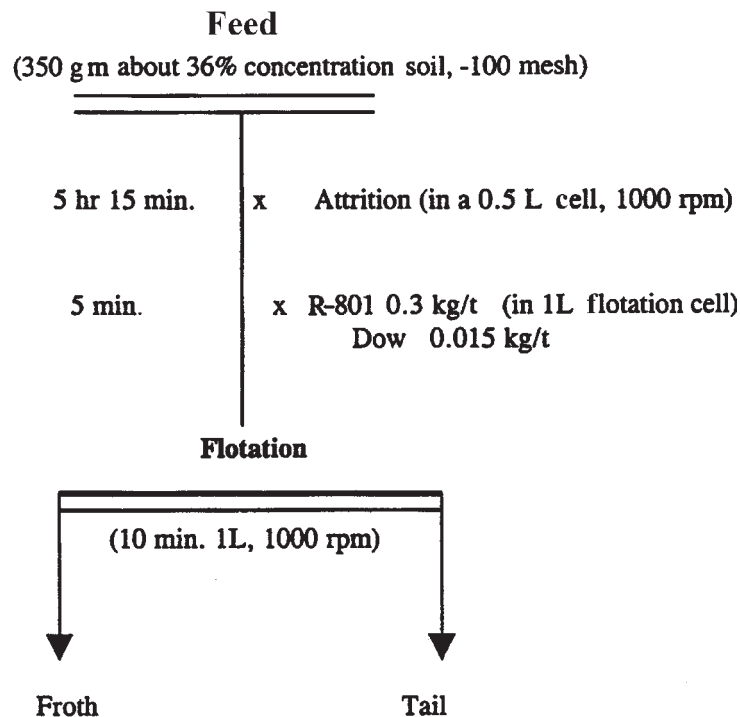

**Figure 22.** Flowsheet of experiment for attritioning before flotation.

**Table 12.** Radium Separation Accounting Data for -100 Mesh Ottawa Soil Sample after Undergoing Attrition Scrubbing

Product	Weight %	Gross Activity (counts)	Distribution (%)
Concentrate	13.77	35	10.33
Tailings	86.23	48.5	89.67

### ***Effect of Ultrasonic Treatment***

The target mineral particles, which are usually floated, need to have clean surfaces so that the collector can effectively adsorb onto them. However, mineral surfaces are often covered with other contaminants, and in some cases they are susceptible to rapid oxidation even at ambient conditions. This contamination and/or oxidation causes the formation of a thin film around the mineral particle, thereby adversely affecting their flotation behavior. It was hypothesized that the radium containing particles could either be prone to oxidation or their surfaces could be cleaned. The coatings on the particles could be broken by an ultrasonic treatment. Therefore, the effect of ultrasonic pretreatment was investigated. Approximately 100 gm of -100 mesh soil was subjected to ultrasonic pretreatment for 10 minutes, followed by pH adjustment at 11 for 5 minutes. Then conditioning was done by Aero R-801 (0.3 kg/ton). The flowsheet is shown in **Figure 23**. The ultrasonic pretreatment results are listed in **Table 13**. The ultrasonic pretreatment did not show the activity separation.

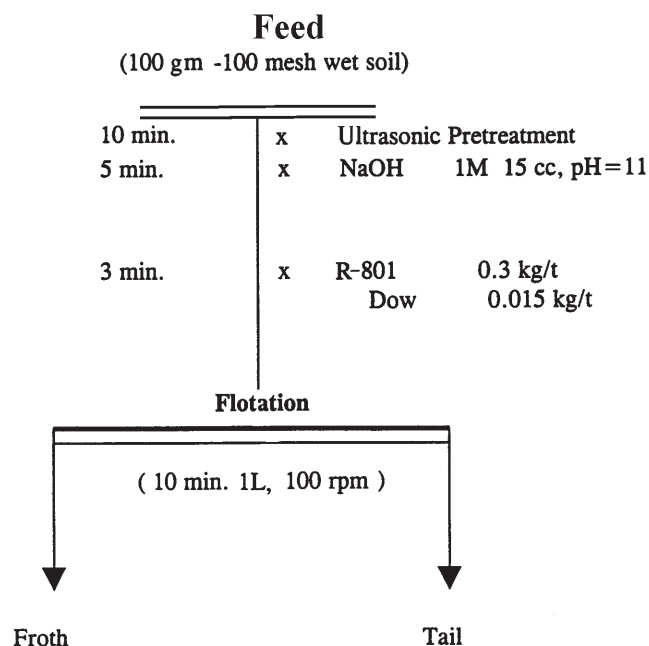

**Figure 23.** Flowsheet of experiment for ultrasonic pretreatment before flotation.

**Table 13.** Radium Separation Accounting Data for -100 Mesh Ottawa Soil Sample after Having Undergone Ultrasonic Pretreatment

Product	Weight %	Gross Activity (counts)	Distribution (%)
Concentrate	25.07	54	29.83
Tailings	74.93	42.5	70.17

### ***Desliming***

Since the initial flotation tests mentioned in **Table 11** and the subsequent improvement efforts (magnetic separation, high pH, attrition scrubbing, ultrasonic pretreatment, etc.) did not result in the improvement of the radium separation, it was concluded that presence of slimes (very fine particles, usually less than 5 micron, containing high activity) in the -100 mesh fraction was the principal factor behind the poor flotation response. This was expected because of the two factors:

1. The presence of excess slimes in flotation systems usually results in poor particle/bubble attachment;
2. Large surface area associated with the slimes tends to oxidize the particles rapidly, thereby, adversely affecting their flotation behavior.

In order to see whether desliming could result in favorable flotation, the soil was fractionated into three fractions; namely, +50 mesh, -50 mesh +10 micron and -10 micron. The flotation response of -50 mesh +10 micron fraction was investigated.

### ***Flotation Tests with -50 mesh +10 micron***

Flotation tests were conducted with -50 mesh + 10 micron size soil fraction. Because this fraction does not contain slimes, it was expected that the flotation results would be favorable. One hundred (100) gm of soil fraction was pulped at natural pH followed by pH adjustment to 10.5. This was followed by conditioning with a collector dosage level of 0.3 kg/ton. The flowsheet of the experiment is shown in **Figure 24**. The desliming pretreatment results are listed in **Table 14**.

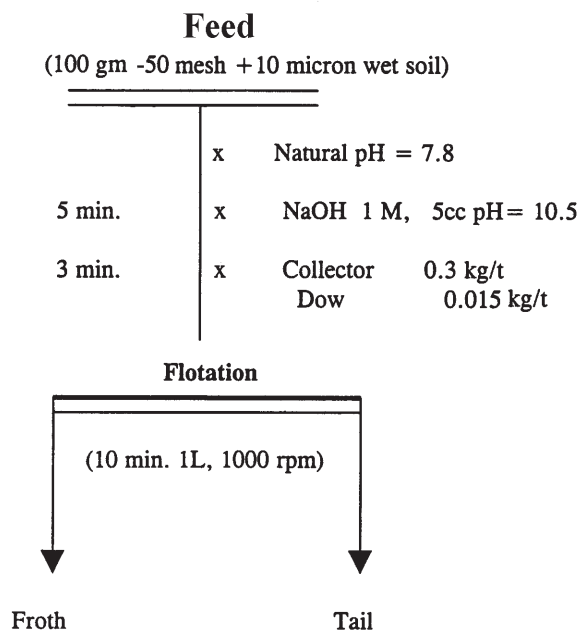

**Figure 24.** Flowsheet of experiment for desliming before flotation.

It is clear from the data that the flotation test results after desliming are encouraging. This is evident from the activity counts of concentrate and tails listed in **Table 14**. The activity counts of concentrate are almost two times that of tails.

**Table 14.** Radium Separation Accounting Data for -50 Mesh +10 Micron Ottawa Soil Sample by Flotation

Collector	Product	Weight %	Gross-activity (Counts)	Activity Distribution (%)
Sodium oleate	Concentrate	7.30	47	13.86
	Tails	92.70	23	86.14
Aero R-801	Concentrate	6.32	44	10.99
	Tails	93.78	24	89.01

**Hot Water Flotation Test**

One hundred (100) gm of 300 x 10 micron soil was pulped and conditioned in hot water at 32°C at pH = 7.6 for 30 minutes. This was followed by the dispersion step for 10 minutes and by addition of sodium silicate at 1.5 kg/ton level to deaggregate soil particles. The collector (R-801) was added at 0.333 kg/ton and conditioning was done for 5 minutes. Then the pulp was diluted at 9% solids and flotation was carried out at 1000 rpm for 5 minutes. The flowsheet of the experiment is shown in **Figure 25**. The results are provided in **Table 15**.

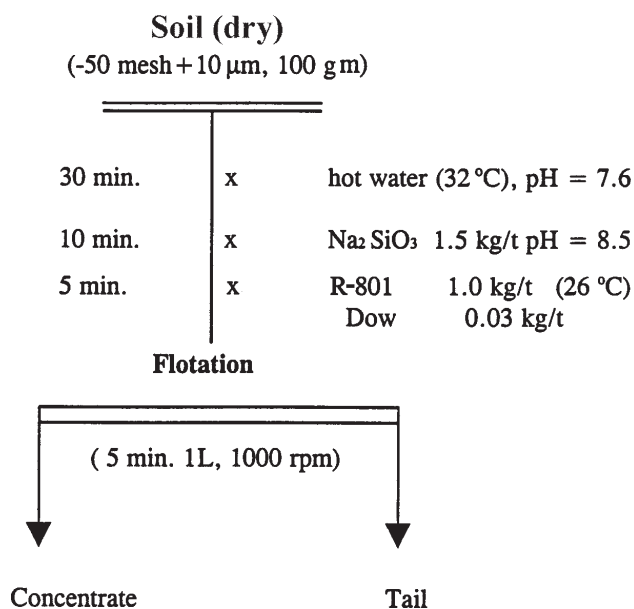

**Figure 25.** Flowsheet of experiment for desliming before hot water flotation.

The data in **Table 15** show the beneficial effect of higher temperature in distributing the radium activity in the concentrate. Note that when flotation was carried out at room temperature under similar conditions, the activity distribution in the concentrate was 11%. Hot water flotation produces a concentrate of higher activity (151 counts as opposed to 44 counts) which is desired; however, the concentrate yield is increased to 14% from 6% which is not desired from the volume reduction point. Therefore, the beneficial effect of running flotation at high temperature may not be economically viable.

**Table 15.** Gross Activity Separation Accounting Data for 300 x 10 Micron Ottawa Soil Sample by Hot Water Flotation at 32°C

Product	Weight (%)	Gross Activity (Counts)	Gross Activity Distribution (%)
Concentrate	13.67	151.4	25.57
Tails	86.33	69.8	74.43

### ***Flotation at Higher Dosage of Aero R-801 (R-801)***

In this test, the collector dosage was doubled (2.0 kg/ton) and the flotation was carried out at room temperature. The flowsheet of the experiment is shown in **Figure 26**. The results listed in **Table 16** show that the use of higher dosage of collector did not improve the separation of radium from soil.

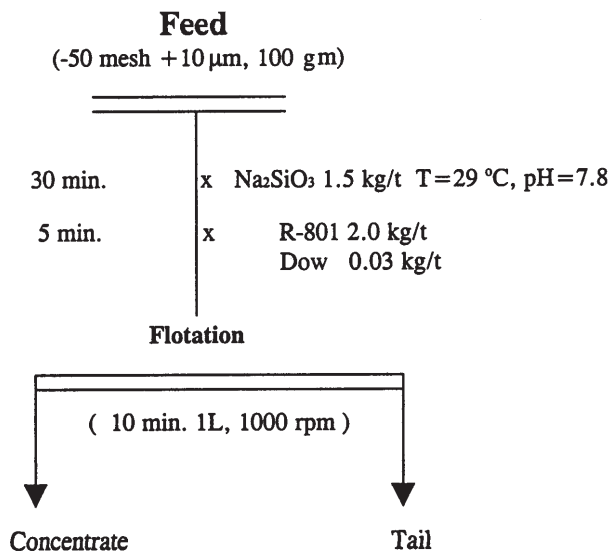

**Figure 26.** Flowsheet of experiment for flotation at higher collector dosage.

**Table 16.** Gross Activity Separation Accounting Data for 300 x 10 Micron Ottawa Soil Sample by Flotation at High Dosage of R-801

Product	Weight (%)	Gross Activity (Counts)	Gross Activity Distribution (%)
Concentrate	14.12	123.7	26.64
Tails	85.88	56	73.36

***Flotation with New Collector 8-Hydroxyquinoline (8-HQ)***

In this test, the collector 8-HQ dosage was raised to 1.5 kg/ton and the flotation was carried out at room temperature. The flowsheet of the experiment is shown in **Figure 27**. The results are listed in **Table 17**.

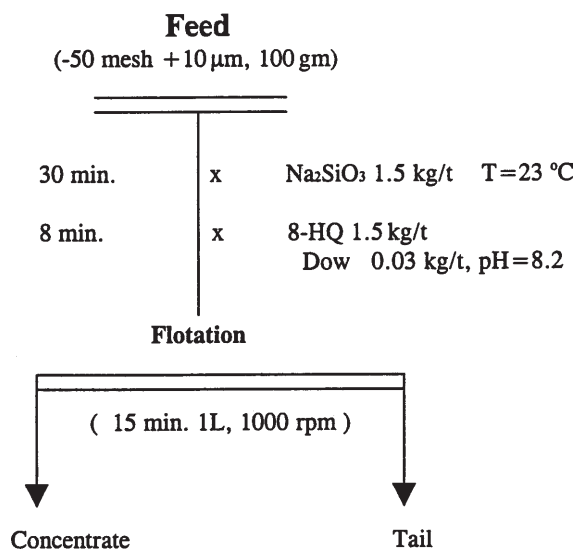

**Figure 27.** Flowsheet of experiment for flotation at higher collector dosage of 8-HQ.

The results in **Table 17** showed that the use of a higher dosage of collector 8-HQ also did not improve the separation.

**Table 17.** Gross Activity Separation Accounting Data for 300 x 10 Micron Ottawa Soil Sample by Flotation at High Dosage of 8-HQ

Product	Weight (%)	Gross Activity (Counts/2 minutes)	Gross Activity Distribution (%)
Concentrate	10.78	51.3	26.16
Tails	89.22	17.5	73.84

### ***Flotation at Higher Dosage of Cupferron***

In this test, the collector Cupferron dosage was fixed at 3.0 kg/ton and flotation was carried out at room temperature. The flowsheet of the experiment is shown in **Figure 28**. The results are listed in **Table 18**.

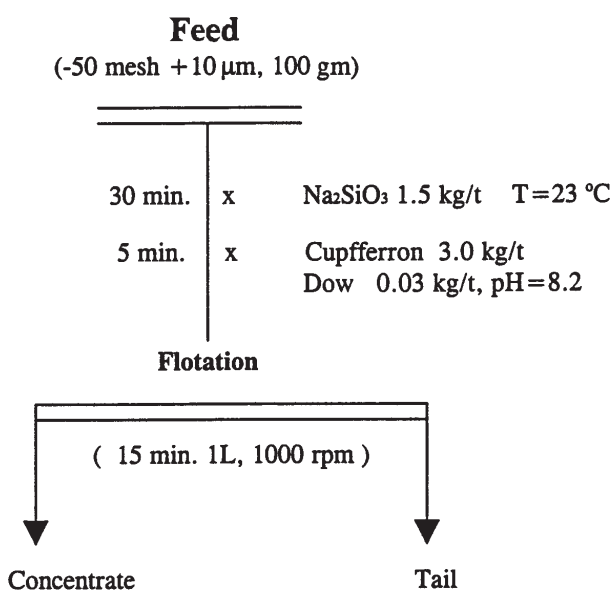

**Figure 28.** Flowsheet of experiment for flotation at higher collector dosage of cupferron.

The results in **Table 18** showed that the use of a higher dosage of collector cupferron again gave comparable results to 8-HQ listed in **Table 17**.

**Table 18.** Gross Activity Separation Accounting Data for 300 x 10 Micron Ottawa Soil Sample by Flotation at High Dosage of Cupferron

Product	Weight (%)	Gross Activity (Counts/2 minutes)	Gross Activity Distribution (%)
Concentrate	10.12	40.25	25.85
Tails	89.88	13	74.15

### ***Flotation by Combining R-801 with 8-HQ Collectors***

In this test, the use of 8-HQ was made at 0.5 kg/ton level in addition to the use of R-801 at 1.0 kg/ton level. The flowsheet of the experiment is shown in **Figure 29**. The results are listed in **Table 19**.

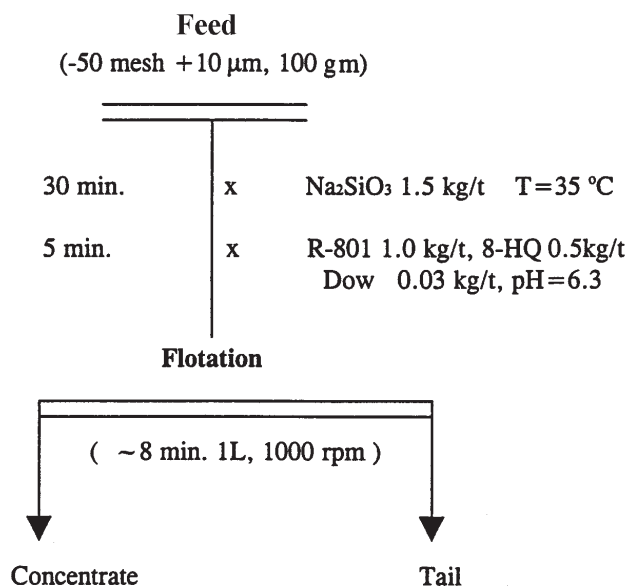

**Figure 29.** Flowsheet of experiment for flotation using combined R-801 and 8-HQ collectors.

**Table 19.** Gross Activity Separation Accounting Data for 300 x 10 Micron Ottawa Soil Sample by Flotation by Combining 8-HQ with R-801

Product	Weight %	Gross Activity (counts/5 minutes)	Gross Activity Distribution (%)
Concentrate	11.77	248	44.36
Tailings	88.23	41.5	55.64

The results listed in **Table 19** show a significant improvement over the results listed in **Tables 15 thru 18**. Interestingly, there is clearly an improvement in both increasing the activity of the concentrate and decreasing the yield of the concentrate. Note that the activity of the concentrate is almost doubled, whereas the yield is reduced by 10%. These effects (i.e., increased activity and decreased yield of concentrate) result in achieving higher radium distribution (44%) in the concentrate compared to 26% listed in **Tables 15 thru 18**.

It is clear from the data that the flotation test results of the combination of R-801/8-HQ were very encouraging. These samples were analyzed by Thermo NUtech for Ra-226 analysis and the results are shown in **Table 20**. It is to be noted that the gross activity data reported in **Table 19** and the Ra-226 activity data reported in **Table 20** are consistent.

**Table 20.** Ra-226 Separation Accounting Data for 300 x 10 Micron Ottawa Soil Sample by Flotation by Combining 8-HQ with R-801

Product	Weight %	Ra-226 Activity (pCi/gm)	Ra-226 Activity Distribution (%)
Concentrate	11.77	175	32.27
Tailings	88.23	49	67.73

## 6.2 Salt Solution Washing/Filtration Tests

### **Coarse Fraction Soil Washing Procedure**

A stirrer, which was reconstructed from the Denver flotation machine, was used as washing equipment (**Figure 30**). The stirrer and air recharge pipe of the Denver flotation machine were uninstalled and replaced with a larger stirrer. A cell, which has a larger height and a smaller bottom length and width, replaced the flotation cell, and plastic film was used to seal the top when the slurry was put into the cell. The volume of the cell was 1 liter.

For each test, the representative feed, weighing about 200 gm sample, was first sampled for feed activity analysis and then mixed with certain water to form about 40% solid by weight in the cell. The desired amount of washing reagent was added into the cell and the slurry was stirred for the desired time. The slurry was filtered and the filtered cake was dried in a low-temperature heater. Finally, the washed soil was sampled and the activity was measured by gas proportional meter or sent to Thermo NUtech.

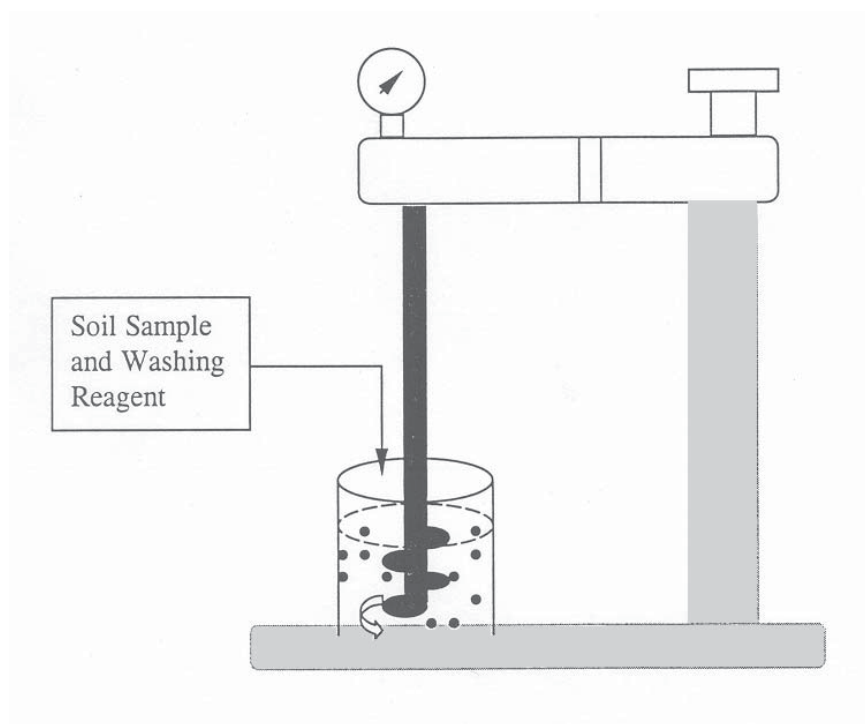

**Figure 30.** Washing test equipment.

### **Fine Fraction Soil Washing Procedure**

The representative feed (-300 mesh) of each washing test weighed 50 gm or less. The feed was first mixed with hot water in a 500 ml beaker, to the required concentration and temperature. Then the required mild salt solution was added into the beaker and a magnetic bar was put into the slurry and the top of the beaker was sealed by plastic film. The beaker was put on a magnetic stirrer with heater to keep the slurry at a constant temperature, and the slurry was stirred for the required time. Finally, the slurry was filtered, and the cake was either used as the feed of another stage washing test or dried to do the count measurements or gamma scan.

### **Washing of -30+50 Mesh Soil with Low Concentration of NaCl/HCl**

In order to test the feasibility of radium decontamination by washing with salt solution for the coarse soil fraction (+50 mesh), it was decided to do a preliminary salt solution washing experiment with -30 +50 mesh soil fraction. This fraction was selected primarily due to analytical reasons only. A 10 gm sample was brought in contact for 30 minutes with 200 cc of solution containing 1M sodium chloride and 0.1 M hydrochloric acid at pH 2.5. After this, the slurry was filtered and the solids were again brought into contact for 30 minutes with 200 cc of water at pH 5.5. Slurry was refiltered. The solids were dried and their gross activity was measured. The flowsheet of the experiment is shown in **Figure 31**



except that only one stage washing was done. The results are shown in **Table 21**. It was interesting to note that the gross activity of the washed Ottawa soil was 12.5 counts, which is very close to the background gross activity of the uncontaminated soil (6 counts). Based on this preliminary data, we believe that +50 mesh soil fraction can be decontaminated to the regulatory level by washing the soil with a mild salt solution.

**Table 21.** Radium Decontamination Data by Salt Solution Washing for -30+50 Mesh Ottawa Soil

Product	Weight %	Gross Activity (counts)	Distribution (%)
Washed soil	92.8	12.5	16.5
Feed soil	100.0	70	100

**Washing of -30+50 Mesh Soil with High Concentration of NaCl/HCl**

In order to test the feasibility of radium decontamination by washing with a higher concentration salt solution for the coarse soil fraction (+50 mesh), it was decided to do a salt solution washing experiment in **two stages** with -30 +50 mesh soil fraction. A 10 gm sample was brought in contact for 30 minutes with 200 cc of solution containing 1 M sodium chloride and 0.1 M hydrochloric acid at pH 2.5. After this, the slurry was filtered and the solids were again brought into contact for 30 minutes with 200 cc of solution containing 1 M sodium chloride and 0.1 M hydrochloric acid pH 5.5. The slurry was refiltered. The solids were dried and their gross activity was measured. The flowsheet of the experiment is shown in **Figure 31**. The results are listed in **Table 22**. It was interesting to note that the gross activity of the washed Ottawa soil was 12.5 counts, which is very close to the background gross activity of the uncontaminated soil (6 counts). The data suggest that the washing of radium can be achieved at low concentration of chlorides, and subsequent rewashing in the chloride solution did not show any improvement.

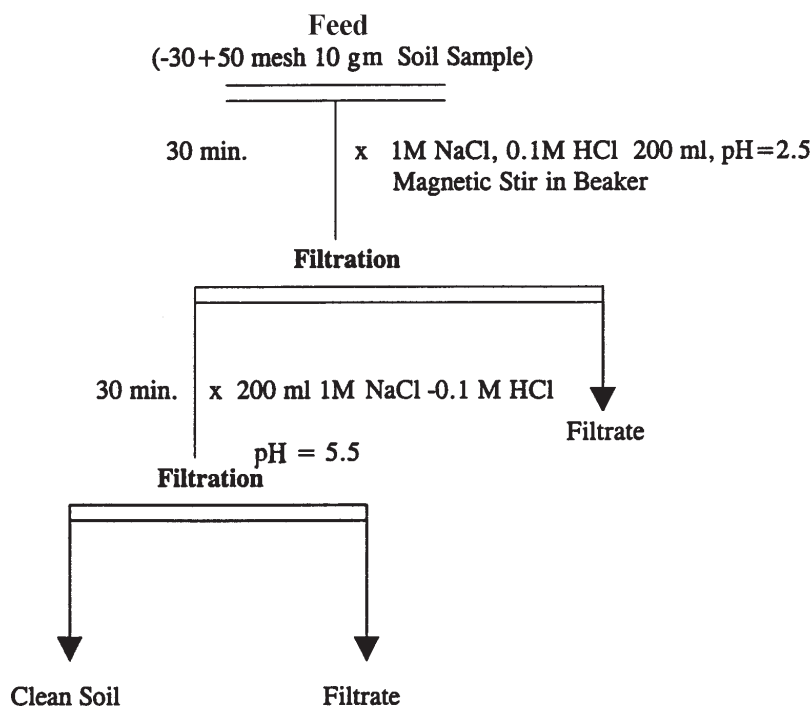

**Figure 31.** Flowsheet of experiment for washing/filtration with NaCl-HCl.

**Table 22.** Gross Activity Decontamination Data by High-Concentration Salt Solution Washing for -30+50 Mesh Ottawa Soil

Product	Weight %	Gross Activity (counts/5 minutes)	Gross Activity Distribution (%)
Washed soil	92.8	12.5	32.22
Feed soil	100.0	70	100

**Washing of 300 x10 Micron Soil with Low Concentration of NaCl/HCl**

In order to compare the base line flotation test results of radium removal against the washing test results, a base line test was conducted using the 300 x 10 micron fraction. Ten (10) gm soil was washed for 3 hours using 200 cc of 1 M NaCl /0.1 M HCl and filtered. The experiment flowsheet is shown in **Figure 32**.

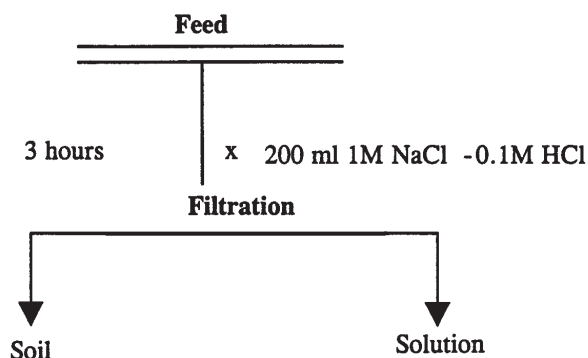

**Figure 32.** Flowsheet of experiment for washing/filtration with NaCl-HCl.

**Washing of -5+50 Mesh Soil with Low Concentration of Chlorides**

In these tests, a different size fraction -5+50 mesh was subjected to washing using a low concentration of chlorides. The salts chosen were 0.75 M calcium chloride and 1 M sodium chloride. Other conditions were the same except that the initial washing was extended to 3 hours from 30 minutes. The experiment flowsheet is shown in **Figure 33**. The activity data is listed in **Table 23**.

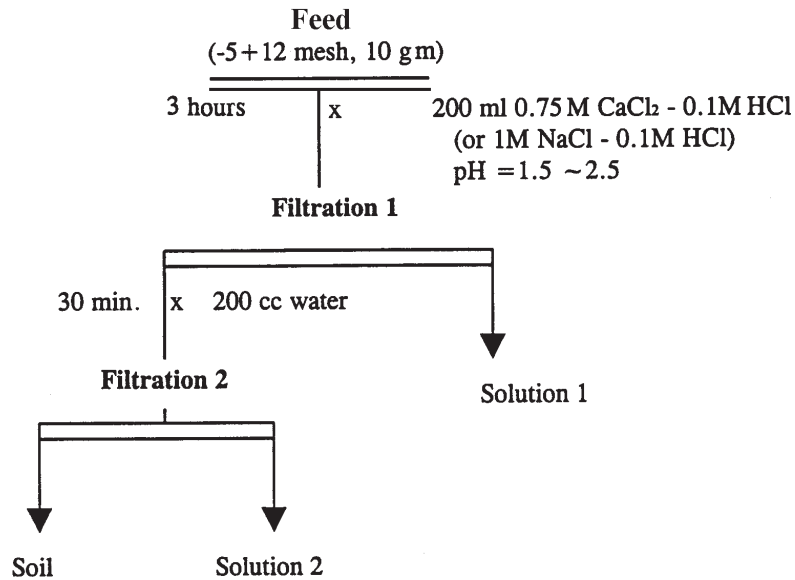

**Figure 33.** Flowsheet of experiment for washing/filtration with NaCl-HCl.

**Table 23.** Gross Activity Decontamination Data by Low Concentration Salt Solution Washing for 300 x 10 Micron Ottawa Soil

Product	Weight %	Gross Activity (counts/5minutes)	Gross Activity Distribution (%)
Soil	90.5	31.6	20.03
Feed	100.0	142.8	100

The data show that even for 300 x 10 micron soil fraction, washing is beneficial in reducing the activity of soil from 143 counts to 32 counts (by a factor of 5). It is, therefore, possible that for this fraction, flotation followed by the salt solution washing can turn out to be an ideal strategy for fully decontaminating the soil. The samples were sent for Ra-226 analysis. The data is listed in **Table 24**. The data reported in **Tables 23** and **24** are consistent.

**Table 24.** Ra-226 Activity Decontamination Data by Low Concentration Salt Solution Washing for 300 x 10 Micron Ottawa Soil

Product	Weight %	Ra-226Activity (pCi/gm)	Ra-226 Activity Distribution (%)
Soil	90.5	14.3	19.88
Feed	100.0	65.1	100

The data listed in **Table 25** show that both calcium chloride and sodium chloride washing separate the radium to the same extent. A sample was also sent to Thermo NUtech for Ra-226 analysis. The data is listed in **Table 26**.

**Table 25.** Gross Activity Decontamination Data by Low Concentration Salt Solution Washing for -5+50 Mesh Ottawa Soil

Reagent	Product	Weight %	Gross-activity (Counts/5 minute)	Gross Activity Distribution (%)
0.75 M CaCl <sub>2</sub> + 0.1M HCl	Washed Soil	94.8	12	23.34
	Feed	100	48.75	100.0
1M NaCl + 0.1M HCl	Washed Soil	96.5	13	25.34
	Feed	100	49.5	100.0

**Table 26.** Ra-226 Decontamination Data by High-Concentration Salt Solution Washing for -30+50 Mesh Ottawa Soil

Product	Weight %	Ra-226 Activity (pCi/gm)	Ra-226 Activity Distribution (%)
Washed soil	96.5	6.2	18.41
Feed soil	100.0	31.6	100

### **Salt Solution Washing/Filtration Tests of -10 Micron Fraction**

A preliminary test was conducted using the -10 micron fraction using the washing conditions previously tested for the coarse size fraction. A 50 gm -10 micron soil sample was washed for 4 hours using 200 cc of 1 M NaCl/0.1 M HCl. The flowsheet of the experiment is shown in **Figure 34**.

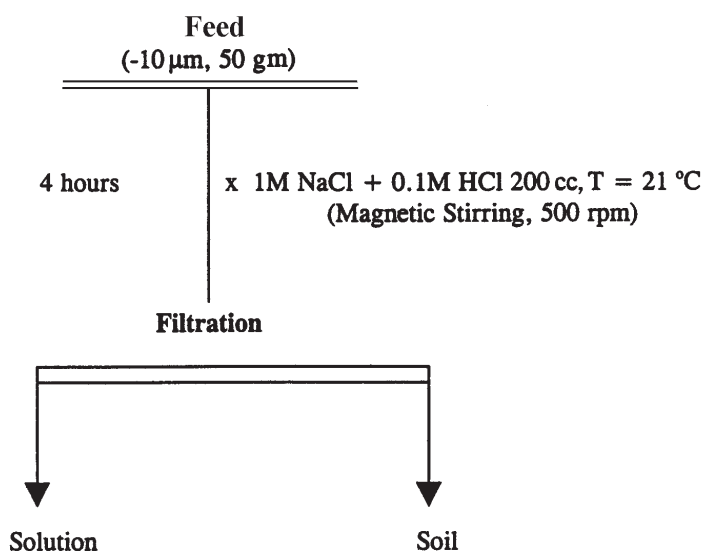

**Figure 34.** Flowsheet of experiment for washing/filtration with NaCl-HCl.

The data in **Table 27** show that the washing conditions developed for the coarse fraction are not suitable to remove the chemically adsorbed and finely entrapped radium from the colloidal particles. Therefore, alternate lixivants and leaching conditions need to be developed for the -10 micron fraction. This set of samples was also sent for Ra-226 analysis; the results are presented in **Table 28**. Based on the Ra-226 analysis, the washing data of -10 micron fraction is very encouraging since approximately 50% of the activity can be removed from the soil.

**Table 27.** Gross Activity Decontamination Data by Washing for -10 Micron Ottawa Soil

Product	Weight %	Gross Activity (counts/2 minutes)	Gross Activity Distribution (%)
Washed soil	94.07	34.3	58.99
Feed soil	100.0	54.7	100

**Table 28.** Ra-226 Activity Decontamination Data by Washing for -10 Micron Ottawa Soil

Product	Weight %	Ra-226 Activity (pCi/gm)	Distribution (%)
Washed soil	94.07	71.1	42.06
Feed soil	100.0	159	100.0

### 6.3 Salt Solution Washing/Sieving Tests

This series of tests were aimed to remove fine particulate solids after washing the coarse fraction. It was hypothesized that this fine particulate, even after getting physically detached from coarse particles, may contribute to the activity of washed soil if not removed from the soil. One possibility was to sieve the soil after washing. The fine particulate passing 65 mesh screen can be processed as part of the -50 mesh +10 micron soil stream.

#### One-Stage Washing/Sieving of -5 +50 Mesh Soil

A 50 gm soil sample was washed with 200 cc of water mixed with 20 cc of 1 M NaCl /0.1 M HCl for 3 hours and 30 minutes. After that, the pulp was sieved at 65 mesh screen. The soil fraction was dried and analyzed. The flowsheet of the experiment is shown in **Figure 35**. The results are listed in **Table 29**. The data show that even after removing the fine particulate, the activity of soil is not reduced.

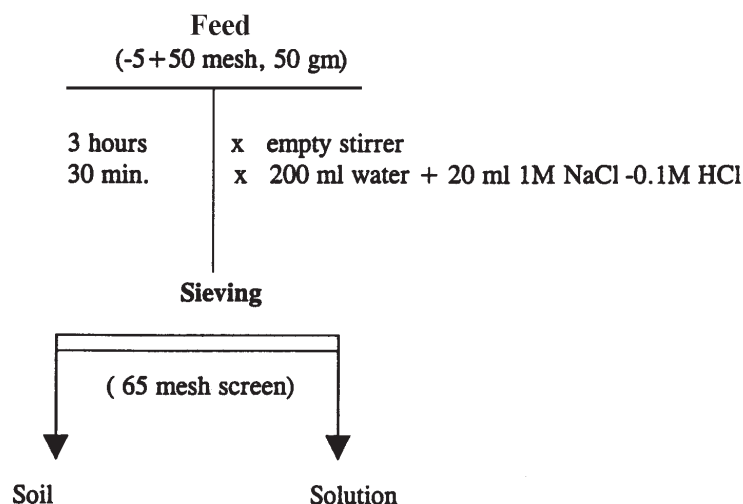

**Figure 35.** Flowsheet of experiment for washing/sieving with NaCl-HCl.

**Table 29.** Gross Activity Decontamination Data by Washing/Sieving for -5+50 Mesh Ottawa Soil

Product	Weight %	Gross Activity (counts/5 minutes)	Gross Activity Distribution (%)
Washed soil	92.0	36.5	58.4
Feed soil	100.0	57.5	100

### Two-Stage Washing/Sieving of -5 +50 Mesh Soil

A 50 gm soil sample was washed with 200 cc of water mixed with 20 cc of 1M NaCl /0.1M HCl for 30 minutes. After that, the pulp was sieved at 65 mesh screen. The soil fraction was then washed with EDTA/water for 30 minutes. After this, the pulp was again sieved at 65 mesh screen. The flowsheet of the experiment is shown in **Figure 36**. The results are listed in **Table 30**. From the data listed in **Table 30**, it is clear that the two-stage washing also did not improve the radium decontamination. Also, the use of EDTA did not improve the results.

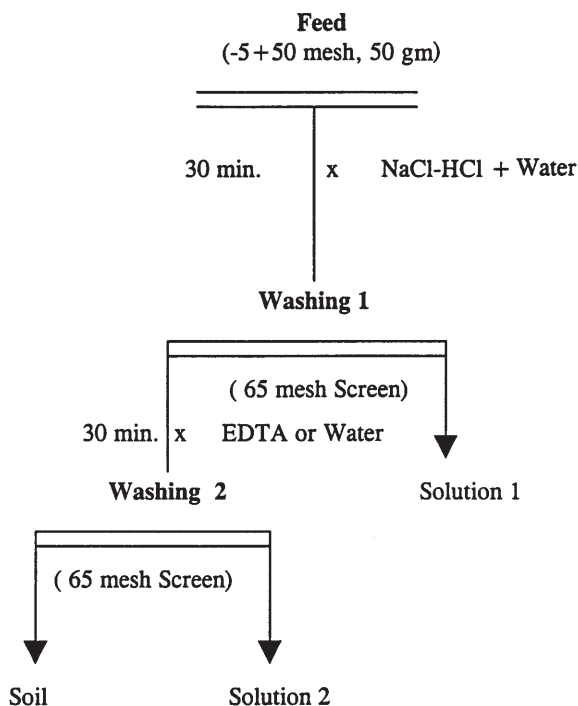

**Figure 36.** Flowsheet of experiment for washing/sieving with NaCl-HCl.

**Table 30.** Gross Activity Decontamination Data by Two-Stage Washing for -5 +50 Mesh Ottawa Soil

Conditions	Product	Weight %	Gross-activity (Counts/5minute)	Gross Activity Distribution( %)
1.20cc 1MNaCl/ 0.1MHCl +200 cc Water 2. 200 cc water	Washed Soil	93.0	43.5	63.41
	Feed	100	63.8	100.0
1.100cc1MNaCl/ 0.1MHCl +100 cc Water 2.200cc 1%EDTA	Washed Soil	86	45.25	60.57
	Feed	100	64.25	100.0

### One-Stage Extended Washing/Sieving of -5 +50 Mesh Soil

These series of tests were done the same way as in the case of one-stage, except that the washing was done for an extended period of time. The flowsheet of the experiment is shown in **Figure 37**. The data are listed in **Table 31**.

The data show that even an extended period of washing did not produce the target results. Samples from this series of tests were also sent for Ra-226 analysis. The results are listed in **Table 32**.

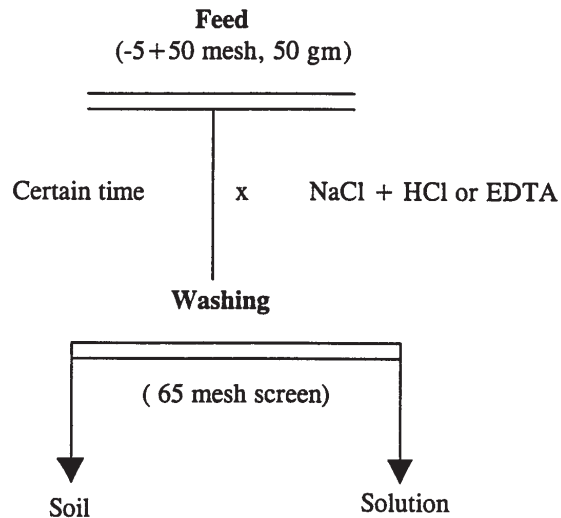

**Figure 37.** Flowsheet of experiment for extended washing/sieving with NaCl-HCl.

**Table 31.** Gross Activity Decontamination Data by One-Stage Extended Washing/Sieving for -5 +50 Mesh Ottawa Soil

Conditions	Product	Weight %	Gross-activity (Counts/5 minutes)	Gross Activity Distribution (%)
200 cc 1MNaCl/ 0.1 MHCl for 3 hours	Washed Soil	98.0	29.25	44.10
	Feed	100	65	100.0
200 cc 1% EDTA for 1 hour	Washed Soil	87.20	37.25	48.48
	Feed	100	67	100.0

**Table 32.** Ra-226 Decontamination Data by One-Stage Extended Washing/Sieving for -5 +50 Mesh Ottawa Soil

Conditions	Product	Weight %	Ra-226 activity (pCi/gm)	Ra-226 Activity Distribution (%)
200 cc 1 MNaCl/ 0.1 MHCl for 3 hours	Washed Soil	98.0	15.1	46.83
	Feed	100	31.6	100.0

## 6.4 Coating Tests

The following series of coating tests were carried out:

- i A 5 gm sample of radium-contaminated soil (-5 micron) from the Ottawa site was mixed with 20 cc of water and different amounts of lime. The lime used was of analytical grade and it was assumed that it did not contain radium. The mixture was allowed to stand for 3 hours. The pH was measured and the slurry was filtered and dried. The activity of soil was measured using a gas proportional counter. **Table 33** depicts the data of the average of four measurements.

**Table 33.** Coating Tests Data for Using -5 Micron Ottawa Soil

Measurement	Feed	5 mg lime	10 mg lime	15 mg lime
pH	7	8.05	9.05	9.4
Activity (Counts/2 minutes)	41	46	41.7	50

The data showed that lime mixed soil does not show a decrease in emission levels. The radon emission is, in fact, higher. It turns out that lime adsorbed particles may crack due to heating resulting in the increase in activity. It is also possible that the filtration may have caused the lime particles to leave the system. Also, the amount of lime used was quite low for the 5 gm soil having a particle size of less than 5 micron. In the next series of experiments, it was targeted to increase the dosage of lime and directly dry the soil.

- i A 2 gm sample of radium-contaminated soil (-5 micron) from the Ottawa site was mixed with 10 cc of water and different amounts of lime. The mixture was allowed to stand for 3 hours. The slurry was heated at 35°C until dried. The activity of soil was measured using a gas proportional counter. **Table 34** provides the data of the average of four measurements.

**Table 34.** Coating Tests Data for Using -5 Micron Ottawa Soil

Measurement	Feed	50 mg lime	50 mg lime + 40 mg sulfate
Activity (Counts/2 minutes)	41	39	106

The data did not show a decrease in activity. In fact, it was surprising to see an increase in activity when a higher proportion of sulfate was used. This may be the interaction of radium sulfate with the added sulfate.

The next series of tests were conducted evaluating the effect of multiple applications.

**Series A:** Coating tests were conducted with lime solution (0.3M, pH12.4). This solution was prepared by dissolving quick lime in water. Two applications were used (each application consisted of 15 ml). The data is listed in **Table 35**.

**Table 35.** Coating Test Results of -5 Micron Ottawa Soil with Quick Lime (0.3M)

Coating #	Application Volume	Activity (Counts)
0	0	42
1	15	38
2	15	39

**Series B:** In another series of tests, calcium hydroxide was used which was dissolved in water at concentration 10 gm/L. The pH was 12.0. The activity reduction data are listed in **Table 36**.

**Table 36.** Coating Tests Results of -5 Micron Ottawa Soil with Calcium Hydroxide (10 gm/L)

Coating #	Application Volume	Activity (Counts)
0	0	41
1	15	39
2	15	42
3	15	38



---

**Series C:** The effect of concentration was also evaluated. In another series of tests, the calcium hydroxide suspension prepared at 150 gm/L was used. The data are listed in **Table 37**.

**Table 37.** Coating Tests Results of -5 Micron Ottawa Soil with Calcium Hydroxide (150 gm/L)

Coating #	Application Volume	Activity (Counts)
0	0	42
1	15	38
2	15	37

**Series D:** In these tests, a suspension of lime solution (10 gm/L) and sodium phosphate (10 gm/L) which had a pH of 12.9 was used. The data are listed in **Table 38**.

**Table 38.** Coating Tests Results of -5 Micron Ottawa Soil with Calcium Hydroxide and Sodium Phosphate (10 gm/L)

Coating #	Application Volume	Activity (Counts)
0	0	43
1	15	41
2	15	39
3	15	38



---

## 7. Conclusions

1. The sieving and sedimentation analysis of the Ottawa soil showed that the contaminated soil had a large size distribution range (coarser than 1700 micron to less than 5 micron).
2. The size analysis data showed that 50% of the soil weight was finer than 150 micron. A significant weight of the soil finer than 150 micron was concentrated primarily into less than 5 micron size. The soil pH was neutral.
3. Ra-226 analysis showed that the activity was distributed in a narrow range of 4-10% for particles coarser than 5 micron. Almost 50% of the activity was associated with particles less than 5 micron in size. The Ra-226 activity ranged from 20 pCi/gm to as high as 180 pCi/gm.
4. The average Ra-226 activity in the coarse +50 mesh (300 micron) fraction was 26.2 pCi/gm, which corresponded to 50% of the soil.
5. A mild chloride washing process was effective in extracting the radium from the coarse size fraction (+50 mesh) and reduced the activity level to 6 pCi/gm.
6. An extensive test program was carried out where several different reagents specific to radium, the effect of temperature, and chloride washing/filtration/sieving alternatives were evaluated.
7. A combination of reagent (R-801 + 8-HQ) was found to be uniquely specific to radium. Using this combined flotation reagent, a volume reduction factor of 80% with a radium level of 6 pCi/gm could be achieved.
8. The tests showed that with chloride washing of coarse soil (+300 micron) and flotation of medium size soil (300x10 micron), an overall volume reduction of 80% can be accomplished.
9. Chloride washing of fine size soil (-10 micron) showed 50% removal of the activity.
10. Coating tests conducted using -5 micron soil with different coating agents and multiple applications did not show reduction in activity attenuation.
11. The gross activity data (counts analysis) collected at UNR using Scalar was used as a quick qualitative guide method and substitute for the Ra-226 gamma scan analysis. Results showed that there was no direct correspondence between the gross alpha and gamma spectroscopy results. This might be attributed to the heterogeneous nature of the radium contamination present in the soil.
12. The flotation recovery of radium from the soil was not good. This can be attributed to the radium content in the soil which is less than 0.001%. Also, the probability of attachment between the hydrophobic radium particles and the air bubbles was low.



## 8. Recommendations

1. It is recommended that alternate lixivants and washing conditions be developed for fine radium-contaminated soil fraction (-10 micron).
2. Flotation tests with medium size fraction showed that more emphasis should be placed on the continued testing and usage of new collectors.
3. Use of microorganisms should be investigated in removing radium from fine soil fraction.
4. It is recommended that an on-site pilot scale demonstration be conducted on the basis of the test work and flowsheet developed in this project. The throughput volume can be as little as 10 lbs./hr to several tons per hour. Considering that the volume of radium-contaminated soil was relatively low and widely scattered, the low throughput rate and low volumes of soil will not be a hindrance in the economics of the process. This is shown in **Figure 38**.

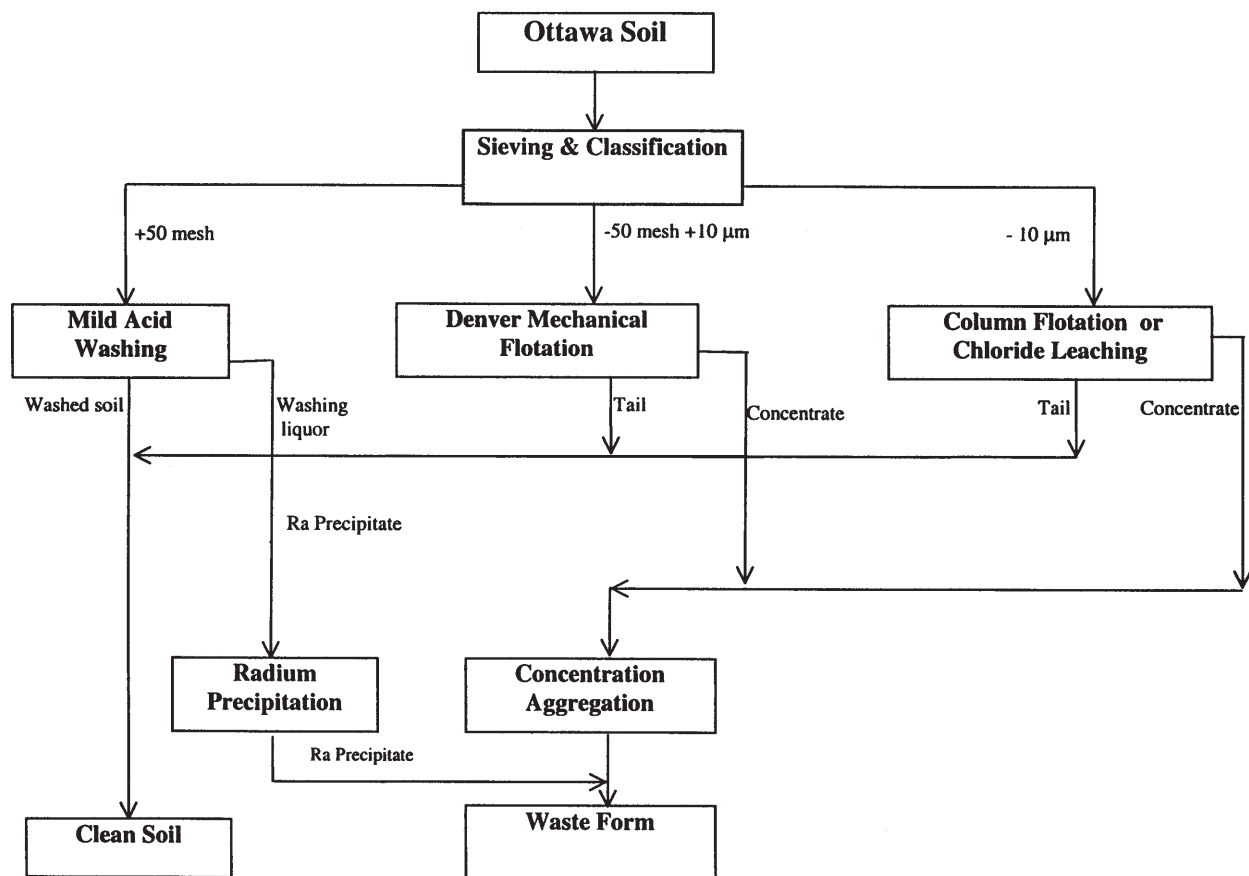

**Figure 38.** Flowsheet for on-site testing.



---

## References

1. M. Misra and R. K. Mehta; 1995. "Remediating Heavy Metals, Radionuclides, and Organic Pollutants from Soils," J. Met., Sept. 1995, pp. 45-53.
2. M. Misra, R. K. Mehta and S. P. Mathur; 1995. "Physical Separation of Radionuclides from Contaminated Soils," Soil & Environment, vol.5, pp. 1093-1101.
3. M. Misra, R. K. Mehta, H. Garcia, C. D. Chai, and R. W. Smith; 1995. "Flotation Separation of Radionuclides from Contaminated Soils from Different DOE Sites," Separation Processes: Heavy Metals, Ions and Minerals (M. Misra ed.), TMS Publication, pp. 111-122.
4. M. Misra, R. K. Mehta, H. Garcia, C. D. Chai, R. W. Smith and S. P. Mathur; 1995. "Application of Physical Beneficiation Techniques for Separation of Radionuclides from Contaminated Soils," SME-Preprint 95-165, 124th SME Annual Meeting, March 6-9, Denver.
5. M. Misra, C. Neve and A. Raichur; 1993. "Characterization and Physical Separation of Radionuclides from Contaminated Soil," in Contaminated Soil '93, P. Arendt et al., (eds.), Kluwer Academic Publishers, The Netherlands, pp. 1623-31.
6. S. P. Mathur and M. Misra; 1994. "Physical Separation of Heavy Metals from Contaminated Soil," Paper Presented at the Second International Symposium and Exhibition on Environmental Contamination in Central and Eastern Europe, Budapest, September 20-23.
7. M. Misra, R. K. Mehta, S. Chen and J. Kimbrell; "Selective Flotation of Ultra-fine Radionuclides from Johnston Atoll Coral Sand," Preprint 96-137; SME Annual Meeting, Phoenix, AZ, March 11-14, 1996.
8. M. Misra, R. K. Mehta, S. Chen and J. Kimbrell; "Physico-chemical Characterization and Flotation of Thorium Contaminated Soil from Kirtland Air Force Base," Preprint 96-150; SME Annual Meeting, Phoenix, AZ, March 11-14, 1996.
9. Nirdosh, I., Muthuswami, S.V. and Baird, M. H. I.; "Radium in Uranium Mill Tailings- Some Observations on Retention and Removal," Hydrometallurgy, 12(1984) 151-176.
10. Demopoulos, G. P.; "Acid Pressure Leaching of a Sulphide Uranium Ore with Emphasis on Radium Extraction," Hydrometallurgy, 15 (1985) 219-242.
11. Final Report - "Heavy Metals in Contaminated Soils Treatability Project," Prepared by MSE, Inc., Under Contract DE-AC22-88ID12735, Sept. 1995, pp. 47.
12. Gerdel, M. A.; Microflotation Investigations of Bastnaesite and Barite, M.S. Thesis, University of Nevada, Reno, 1985.
13. Mohal, B. R.; Microflotation Studies of Hexadecyl Sulfate Flotation of Barite, M.S. Thesis, University of Nevada, Reno, 1984.
14. Muthuswami, S.V., S. Vijayan, D.R. Woods, and S. Banerjee; "Flotation of Uranium from Ores in Canada," Can. J. Chem. Eng., 61(1983) 728-744.
15. Raicevic, D.; "Decontamination of Elliot Lake Uranium Tailings," CIM Bull., 72(808) (1979), 109-115.
16. Seeley, F.G.; "Problems in the Separation of Radium from Uranium Ore Tailings," Hydrometallurgy, 2 (1976/1977) 249-263.



United States  
Environmental Protection  
Agency

National Risk Management  
Research Laboratory  
Cincinnati, OH 45268

Official Business  
Penalty for Private Use  
\$300

EPA/600/R-01/099  
December 2001

Please make all necessary changes on the below label,  
detach or copy, and return to the address in the upper  
left-hand corner.

If you do not wish to receive these reports CHECK HERE ;  
detach, or copy this cover, and return to the address in the  
upper left-hand corner.

PRESORTED STANDARD  
POSTAGE & FEES PAID  
EPA  
PERMIT No. G-35